

User & Installation Manual

LT-4100 Satellite Communications System

Iridium Certus® 100

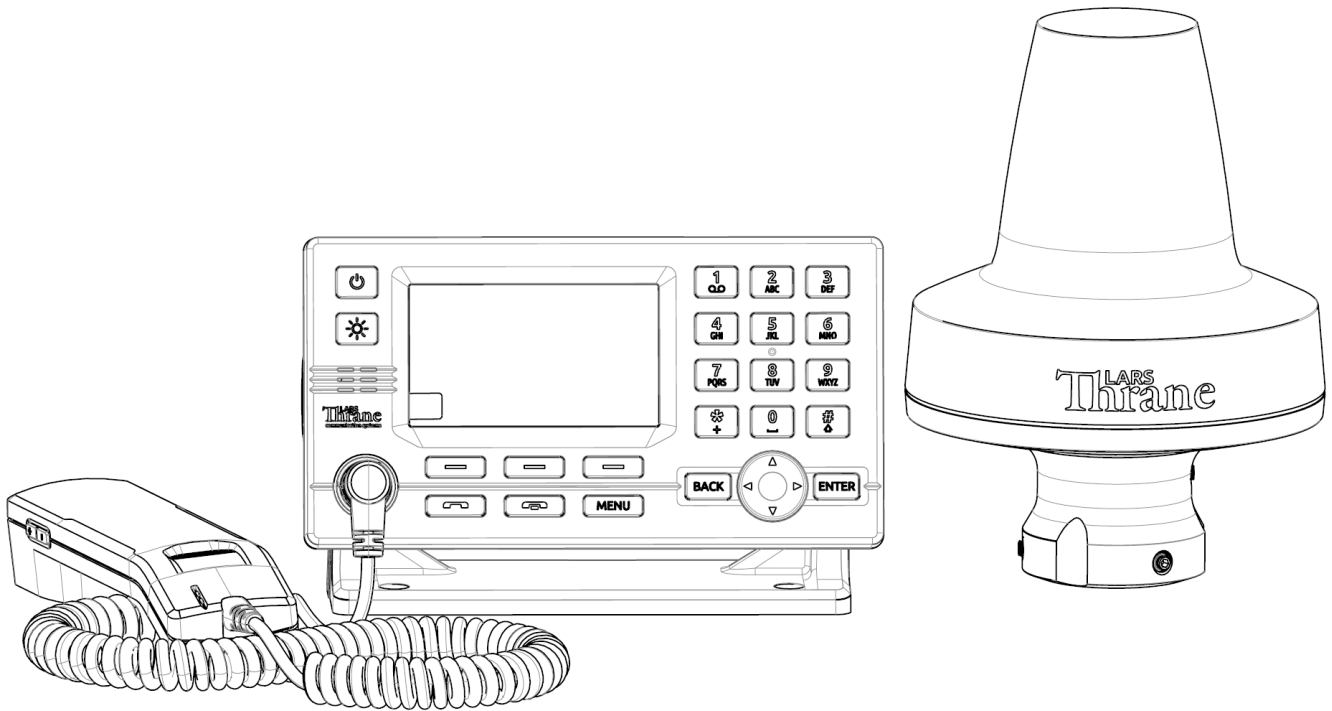

Document Number: 95-102576 Rev. 1.03

Release date: June, 2023

Copyright © Lars Thrane A/S

Denmark

ALL RIGHTS RESERVED

This Document is of © copyright to Lars Thrane A/S. It contains proprietary information, which is disclosed for information purposes only. The contents of this document shall not in whole or in part be used for any other purpose without prior permission from Lars Thrane A/S.

Disclaimer

Any responsibility or liability for loss or damage in connection with the use of this product and the accompanying documentation is disclaimed by Lars Thrane A/S. The information in this manual is provided for information purposes only, is subject to change without notice, and may contain errors or inaccuracies. Manuals issued by Lars Thrane A/S are periodically revised and updated. Anyone relying on this information should acquire the most current version e.g. from Lars Thrane A/S. Lars Thrane A/S is not responsible for the content or accuracy of any translations or reproductions, in whole or in part, of this manual from any other source.

Copyright

© 2023 Lars Thrane A/S. All rights reserved.

Disposal

Old electrical and electronic equipment marked with this symbol can contain substances hazardous to human beings and the environment. Never dispose these items together with unsorted municipal waste (household waste). In order to protect the environment and ensure the correct recycling of old equipment as well as the re-utilization of individual components, use either public collection or private collection by the local distributor of old electrical and electronic equipment marked with this symbol. Contact the local distributor or dealer for information about what type of return system to use.



IMO and SOLAS

The equipment described in this manual is intended for use on commercial marine and leisure vessels. The equipment is not covered by the International Maritime Organization (IMO) and Safety of Life at Sea (SOLAS) regulations.

Safety Instructions for Installer & Operator

The following safety instructions must be observed during all phases of operation, installation, service and repair of this equipment. Failure to comply with these precautions or with specific warnings elsewhere in this manual violates safety standards of design, manufacture and intended use of the equipment.

Lars Thrane A/S assumes no liability for the customer's failure to comply with these requirements.

Instructions for the Installer

WARNING - Product installation

To ensure correct performance of this equipment, it is strongly recommended that professionals with expertise, properly trained, and likewise authorized within the industry is completing the installation.

WARNING – Turn off power switch

Turn off the main power switch before installing the equipment described in this manual. Do not connect or disconnect equipment when the main power switch is on.

WARNING – Use only the supplied cable

Use only the supplied power and communication cable for connecting the equipment.

WARNING – Input Power

The input voltage range is: 12-24 VDC (2.0-1.0A).

WARNING – Power supply protection

Make sure that the power supply is adequately protected by a fuse or an automatic circuit breaker when installing the equipment (15.0 A).

WARNING - Explosive atmosphere

Do not operate the equipment in the presence of flammable gases or fumes. Operation of any electrical equipment in such an environment constitutes a definite hazard.

WARNING - Compass safe distance

The compass safe distance for standard and steering compasses is 1.40 m (4.6 ft) and 0.90 m (3.0 ft) respectively. Observe these distances to prevent interference to a magnetic compass.

Instructions for the Operator

WARNING – Do not disassemble

Do not disassemble or modify this equipment. Fire, electrical shock, or serious injury can result.

WARNING – Keep away from live circuits

Operational personnel must not remove product enclosure. Do not service the equipment with the communication cable connected. Always disconnect and discharge unit, cable and circuits before touching them.

WARNING - Permanent watch

In case of smoke or water leaks into the equipment, immediately turn off the power. Continued use of the equipment can cause fire or electrical shock. Keep access and permanent watch of the equipment in order to prevent any unwanted escalation.

WARNING – DC mains connector

The DC mains connector is to be used as the disconnection device to isolate the equipment from the mains supply.

IMPORTANT - Safety distance

The safety distance from the LT-4130 Antenna Unit, when the LT-4130 Antenna Unit is powered and transmitting, is 0.2 m (0.7 ft), in order to comply with the regional regulations.

Always keep this safety distance to the LT-4130 Antenna Unit to avoid any serious injury.

If the safety precautions and warnings on this site are not followed, warranty will be void.

**IMPORTANT – FCC Compliance Note:**

This equipment has been tested and found to comply with the limits for a Class B digital device, pursuant to part 15 of the FCC Rules. These limits are designed to provide reasonable protection against harmful interference in a residential installation. This equipment generates, uses and can radiate radio frequency energy and, if not installed and used in accordance with the instructions, may cause harmful interference to radio communications. However, there is no guarantee that interference will not occur in a particular installation. If this equipment does cause harmful interference to radio or television reception, which can be determined by turning the equipment off and on, the user is encouraged to try to correct the interference by one of the following measures:

- Reorient or relocate the receiving antenna.
- Increase the separation between the equipment and the receiver.
- Connect the equipment into an outlet on a circuit different from that to which the receiver is connected.
- Consult the dealer or an experienced radio/TV technician for help.

This product does not contain any user-serviceable parts.

Repairs should only be made by an authorized Lars Thrane A/S service center. Unauthorized repairs or modifications could result in permanent damage to the equipment and void your warranty and your authority to operate this device under Part 15 regulations.

**IMPORTANT – Innovation, Science and Economic Development Canada Compliance Note:**

This device complies with Innovation, Science and Economic Development Canada license-exempt RSS standard(s). Operation is subject to the following two conditions: (1) this device may not cause interference, and (2) this device must accept any interference, including interference that may cause undesired operation of the device.

Required information for the reader

Throughout this document, essential information will be presented to the reader. The following text (emphasized) has the following meaning and/or implication:

WARNING: A 'Warning' is an Operation or Service procedure that, if not avoided, may cause a hazard situation, which could result in personnel death or serious injury.

IMPORTANT: Text marked 'Important' provides essential information to the reader and is key information to the user for the equipment to work properly. Damage to the equipment can occur if instructions are not followed.

NOTE: A 'Note' provides essential information to the reader.

About this manual

Intended readers

This is a User & Installation Manual for LT-4100 Satellite Communications System, or LT-4100 system. The manual is primarily intended for installers and service personnel.

Personnel installing or servicing the system should be professionals with technical expertise, properly trained, and likewise authorized.

All safety instructions and guidelines in this manual must be observed. The safety instructions are listed in the beginning of the manual. The guidelines are to be found in the separate chapters, where it is needed.

Software versions

This manual is applicable to the following software:

Software Versions		
Description	P/N	Version
LT-4100 System	71-102366	1.04R

Table 1: Software Versions

IMPORTANT: The latest software released by Lars Thrane A/S must always be used for new installations of the LT-4100 System and should be updated to ensure the best possible performance of the system and services.

NOTE: The latest LT-4100 Software and Release Notes can always be downloaded from the Lars Thrane A/S website. Please contact Lars Thrane A/S for details about future software releases and features.

Record of Revisions

Rev.	Description	Release Date	Initials
1.00	Original document.	October, 2021	KTL
1.01	DNS Server and Cache. Firewall DNS rules (whitelist DNS and/or IP addresses). NMEA 0183 GNSS over UDP (broadcast on LAN or Bluetooth).	December, 2021	KTL
1.02	PPPoE Certus Voice Services changed to Supplementary Services Updated Data section Added description of LT-4100 DNS Server Updates to Web Server Updated LT-4110 Control Unit Input Power	April, 2023	KTL
1.03	Updated and added several chapters (incl.) DNS PPPoE Reset Options Static Route Removed Bracket Mount (1.5" to 2.5" pipe), Antenna Unit Updated Galvanic Isolated Power Supply Added Note on Bluetooth module availability for LT-4110 CU Editorial Corrections	June, 2023	KTL

Table of Contents

Introduction	1
Application and Limitations.....	2
Unpacking (in-the-box)	3
Inspection.....	3
Accessories.....	4
Mounts	4
Cable and connectors	4
System Overview	5
Installation and Mounting.....	6
LT-4110 Control Unit.....	6
LT-3120 Handset	9
LT-3121 Cradle.....	10
LT-4130 Antenna Unit.....	11
Pole Mount (1.5" pipe, Ø38.8mm), Antenna Unit.....	19
Pole Mount (2.0" pipe, Ø53.0mm), Antenna Unit.....	21
Interfaces.....	23
LT-4110 Control Unit.....	23
LT-4130 Antenna Unit.....	32
Power Consumption	34
Maximum	34
DC Isolation Resistance and Chassis Ground	35
Galvanic Isolated Power Supply	37
AC/DC Galvanic Isolated Power Supply	37
DC/DC Galvanic Isolated Power Supply	37
User Interface (UI).....	38
Display.....	39
Menu System	43
Activating the System.....	45
Acquire a Certus SIM Card	45
Postpaid Voice Features	45
Who's My Service Provider	46
Change of Hardware and Software	47
Change of Hardware	47

Software Update	48
System Services	49
Voice Call	49
Data	54
Bluetooth	60
System Submenus	63
Phone	63
Settings	66
System	74
Bridge Alert Management (BAM)	79
Serial Interface (RS-422)	83
GNSS sentences	83
BAM sentences	84
NMEA 0183 over UDP	85
Web server	86
Accessing the built-in web server	87
Dashboard	88
Configuration	89
Maintenance	115
Legal notice	118
Log out	118
Disable login timeout	118
Service & Repair	119
Appendixes	120
App. A Applicable Standards	120
App. B Bridge Alert Management (BAM)	121
App. C Multiple talkers and multiple listeners	125
App. D GNSS sentences	126
App. E BAM Sentences	127
App. F GNSS Receiver Integrity States	128
App. G - Specifications	133
App. H - Outline Drawing: LT-4110 Control Unit	134
App. I - Outline Drawing: Bracket Mount, Control Unit	135
App. J - Outline Drawing: Flush Mount, Control Unit	136

App. K - Outline Drawing: LT-4130 Antenna Unit	137
App. L - Outline Drawing: Pole Mount (1.5" pipe, 38.8mm), Antenna Unit	138
App. M - Outline Drawing: Pole Mount (2.0" pipe, 53.0mm), Antenna Unit	139
App. N - Outline Drawing: LT-3120 Handset	140
App. O - Outline Drawing: LT-3121 Cradle	141

Introduction

Congratulations on your purchase of the LT-4100 Satellite Communications system - Iridium Certus® 100!

The LT-4100 Satellite Communications System is a maritime satellite communication product from Lars Thrane A/S. The LT-4100 system is designed for the professional market (deep sea, fishing, and workboats), but can be used for the leisure market as well. The LT-4100 system meets all standards and certification requirements needed for worldwide maritime satellite communication equipment.

The LT-4100 system has voice and data capabilities with 100% global coverage provided by the Iridium® Communications Network. The LT-4100 system offers the following Iridium services:

- 2 x Voice Channels (high quality)
- IP-data: 22 kbps (up) / 88 kbps (down)

The LT-4100 system consists of a control unit, antenna unit, handset, and cradle.

A single coaxial cable connects the control unit with the antenna unit. Using a standard coaxial cable, up to 500 meters of separation between the units can be obtained, giving freedom to mount the antenna unit in the best possible location, with free line of sight to the Iridium satellites.

The LT-4100 system can be used as the primary satellite communication product on vessels, covering the basic communication needs in terms of connectivity between the ship and shore and ship to ship.

Application and Limitations

- The LT-4100 system shall be installed according to manufacturer's User & Installation Manual.
- The LT-4100 system includes an integrated Global Navigation Satellite System (GNSS) receiver for position fixing.
- The LT-4130 Antenna Unit operational low temperature is: -40°C (-40°F)

Unpacking (in-the-box)

Unpack the LT-4100 Satellite Communications System - Basic (P/N: 90-102608) and check that the following items are present in the box:

- 51-102663 LT-4110 Control Unit
- 51-100988 LT-3120 Handset
- 51-101181 LT-3121 Cradle
- 51-102365 LT-4130 Antenna Unit
- 91-100771 Bracket Mount, Control Unit
- 91-102118 Power Cable, 3m
- 4 x Stainless steel A4 screws (for Bracket Mount, Control Unit)
- 2 x Stainless steel A4 screws (for Cradle)
- 4 x Unit Test Sheets
- 95-102576 LT-4100 User & Installation Manual

NOTE: Antenna unit mounts are not included in the LT-3100S GMDSS Satellite Communications System - Basic (P/N: 90-102071) and must be ordered separately. The antenna unit must only be mounted, using a pole mount, delivered by Lars Thrane A/S. The antenna unit mounts are listed with part numbers (P/N) in *Accessories* on page 4.

Inspection

Inspect the shipping cartons and/or wooden box immediately upon receipt for evidence of damage during transport. If the shipping material is severely damaged or water stained, request that the carrier's agent is present when opening the cartons and/or wooden box. Save all box packing material for future use.

After unpacking the system and opening the cartons, inspect it thoroughly for hidden damage and loose components or fittings. If the contents are incomplete, if there is mechanical damage or defect, or if the system does not work properly, notify your distributor.

WARNING: To avoid electric shock, do not apply power to the LT-4100 system components if there is any sign of shipping damage to any part of a unit or the outer cover. Read the Safety Instructions at the front of this manual before installing or operating the system.

Accessories

Mounts

The following accessory parts are not part of the basic system and must be ordered separately:

- 91-100772 Flush Mount, Control Unit
- 91-100774 Pole Mount (1.5" pipe, Ø38.8mm), Antenna Unit
- 91-102550 Pole Mount (2.0" pipe, Ø53.0mm), Antenna Unit

Cable and connectors

The following cable and connector parts are not part of the basic system and must be ordered separately:

- 91-100768 Aux Cable, 3m
- 91-101183 Coaxial cable Ø4.9mm, 10m
- 91-101184 Coaxial cable Ø4.9mm, 25m
- 91-101137 Coaxial Cable Ø10.3mm 10m
- 91-101138 Coaxial Cable Ø10.3mm 25m
- 91-101139 Coaxial Cable Ø10.3mm 50m
- 91-101140 N Conn. (male) for Coaxial Cable Ø4.9mm
- 91-101186 N Conn. (male) for Coaxial Cable Ø10.3mm
- 91-101187 Crimping Tool for Coaxial Cable Ø4.9mm
- 91-101188 Crimping Tool for Coaxial Cable Ø10.3mm

Coaxial cables are delivered with one fixed N connector (outdoor mounting), another loose N connector and crimp parts comes with the cable. It is required to use an appropriate crimping tool for attaching the loose N connector.

NOTE: For further details on the cable and connectors, please contact Lars Thrane A/S. A coaxial cable up to a length of 500 meters can be used for connecting the LT-4110 Control Unit and the LT-4130 Antenna Unit. Details about the coaxial cable, specification, and cable lengths, are described in *LT-4130 Antenna Unit* on page 11.

System Overview

The LT-4100 Satellite Communications System is a standalone communication product, which uses the Iridium® satellite constellation. The LT-4100 system is working on the Iridium® NEXT satellites. An overview of the LT-4100 system is illustrated in Figure 1.

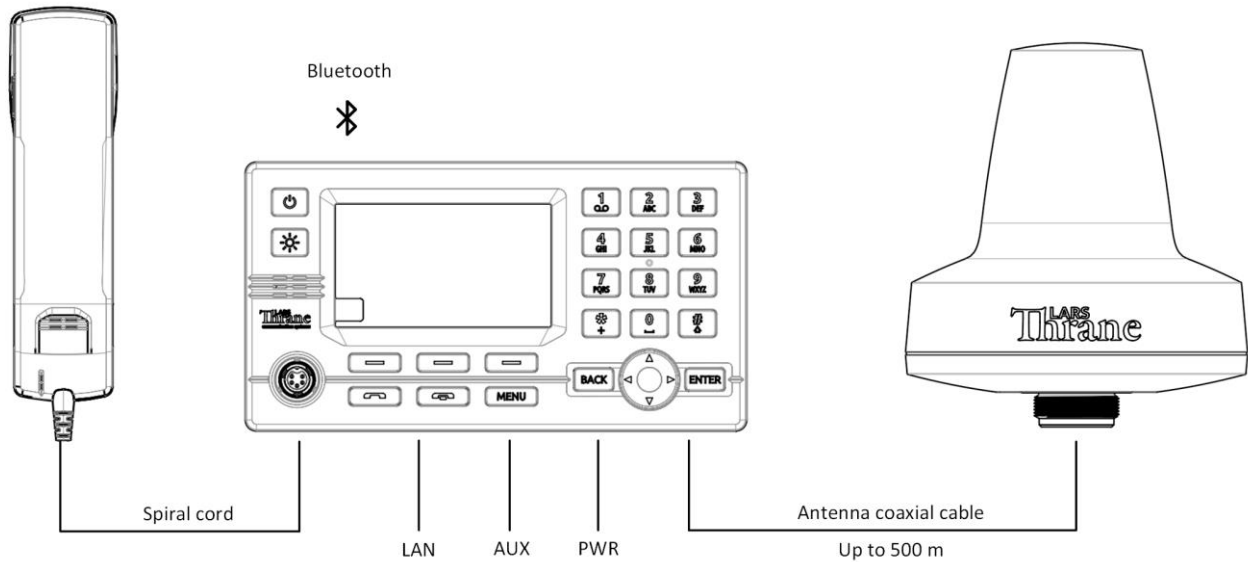

Figure 1: LT-4100 system - basic components and interfaces.

The LT-4100 system consists of the following units, provided by Lars Thrane A/S:

- LT-4110 Control Unit
- LT-3120 Handset
- LT-3121 Cradle
- LT-4130 Antenna Unit

NOTE: The built-in Bluetooth module and functionality will not be available in future production of the LT-4110 Control Unit due to manufacturer shortage and component obsolescence. In the display / GUI (MENU -> Settings -> Bluetooth) it can be verified if the Bluetooth module is mounted or not (the Bluetooth submenu will only be shown if the module is mounted).

Installation and Mounting

LT-4110 Control Unit

The LT-4110 Control Unit is the master unit in the system, supporting all external interfaces and the operational user interface. The LT-4110 Control Unit is designed for indoor mounting. Check the specifications in *App. G - Specifications* on page 133.

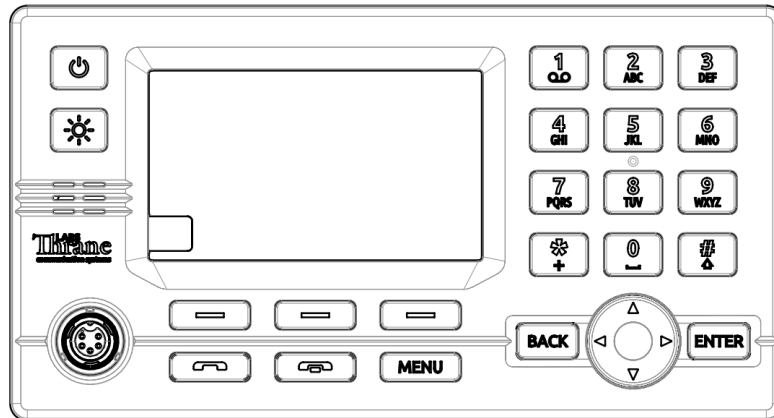

Figure 2: LT-4110 Control Unit (front view).

The LT-4110 Control Unit has the following interfaces:

- 4-pin power connector (male), marked 'PWR'
- Chassis ground connector, marked 'GNDC'
- N connector (female) for coaxial cable to the LT-4130 Antenna Unit, marked 'ANT'
- Ethernet (RJ-45) connector, marked 'LAN'
- 10-pin auxiliary connector (male), marked 'AUX'
- SIM card, marked 'SIM'
- 5-pin connector (female) for LT-3120 Handset (front of the control unit)

The interfaces on the back side of the LT-4110 Control Unit are illustrated in Figure 3 on page 7.

The LT-4110 Control Unit interfaces are described in *Interfaces on page 23*. The LT-4110 Control Unit, front and backside view, are illustrated in Figure 2 and Figure 3.

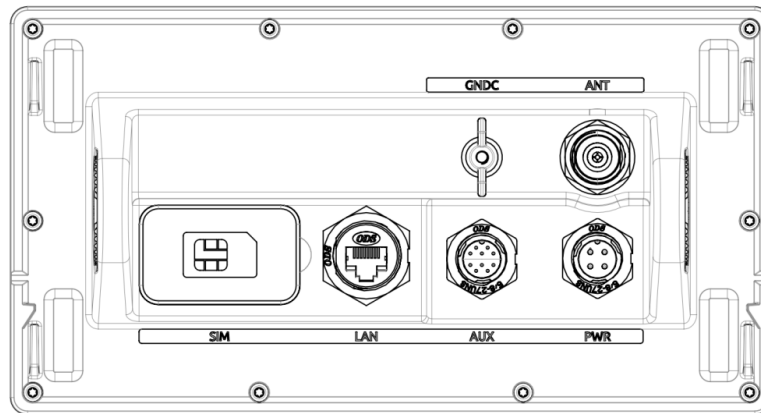

Figure 3: LT-4110 Control Unit (backside view).

The LT-4110 Control Unit user interface, display and buttons, are described in *User Interface (UI) on page 38*.

NOTE: The LT-4110 Control Unit must be mounted with either the Bracket Mount, Control Unit (P/N: 91-100771) or Flush Mount, Control Unit (P/N: 91-100772) - illustrated in Figure 4 and Figure 5. The Flush Mount, Control Unit is not included in the LT-4100 Satellite Communications System - Basic (P/N: 90-102608) and must be ordered separately.

Mounting and installation considerations:

For optimum system performance, the following guidelines on where to install and mount the LT-4110 Control Unit must be followed. It is recommended to mount the unit in a location, which fulfills these requirements:

- Mount the unit indoor (not exposed to direct water)
- Mount the unit using either the bracket mount or flush mount
- Mount the unit on a rigid structure with a minimum of exposure to vibration and shock
- Mount the unit in an area with an ambient temperature between -15°C to +55°C (+5°F to +131°F)

The Bracket Mount and Flush Mount for the LT-4110 Control Unit are illustrated in Figure 4 and Figure 5.

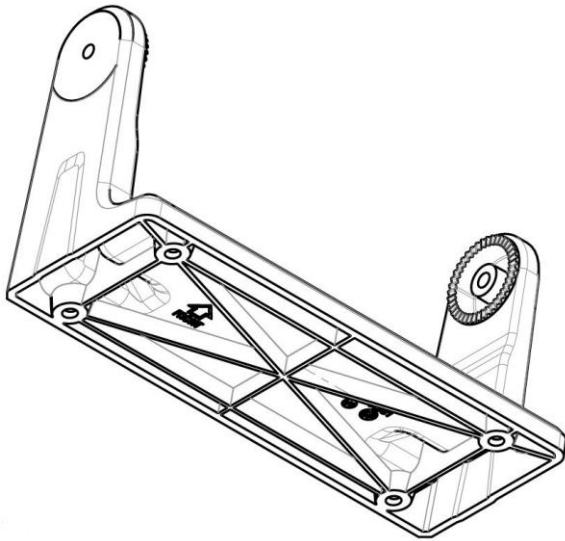

Figure 4: Bracket Mount, Control Unit.

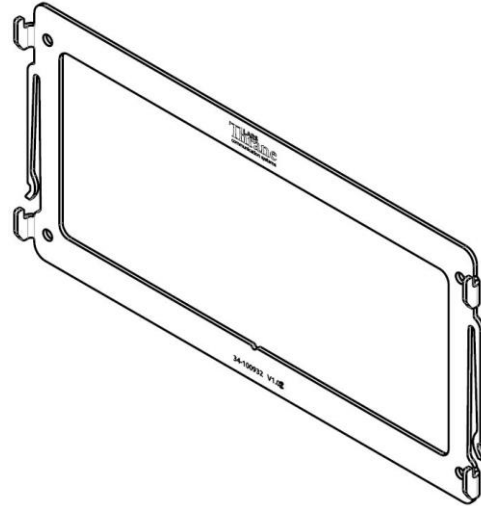

Figure 5: Flush Mount, Control Unit.

LT-3120 Handset

The LT-3120 Handset is the primary voice interface for the LT-4100 system. The LT-3120 Handset must be connected on the front of the LT-4110 Control Unit. The connector is illustrated in Figure 2 on page 6.

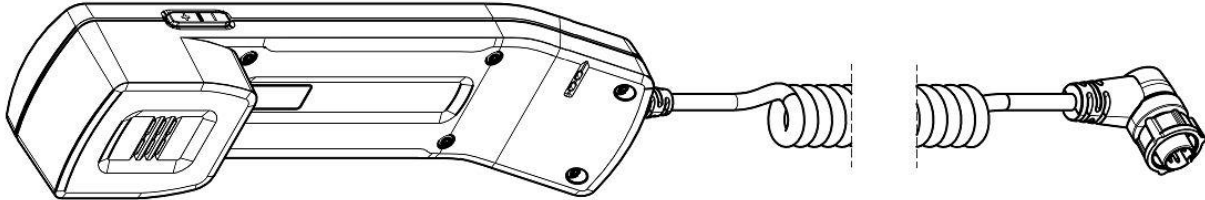

Figure 6: LT-3120 Handset (front view).

The LT-3120 Handset is connected to the LT-4110 Control Unit via a 5-pin proprietary angle connector. The spiral cord, fixed to the LT-3120 Handset is ~ 0.4 m from handset to connector, when coiled. The spiral cord can be stretched to a maximum of 2 m. The LT-3120 Handset is designed for indoor mounting. Check the specifications in *App. G - Specifications* on page 133.

The LT-3120 Handset has the following characteristics:

- High-performance audio speaker and microphone
- Separate ringer (buzzer)
- Speaker volume control (double-button, marked with '+' and '-', for volume up and down)
- Built-in off-hook detection circuit

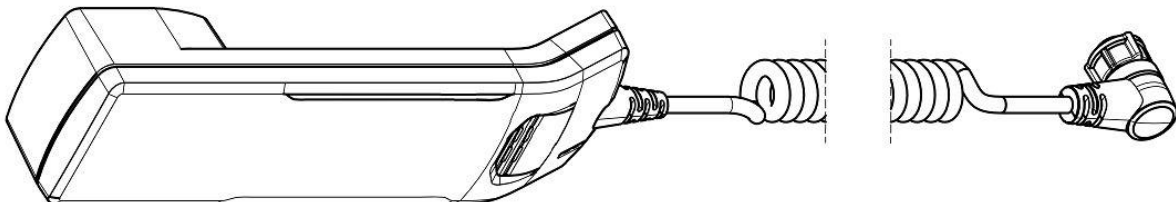

Figure 7: LT-3121 Handset (back view)

NOTE: The LT-4110 Control Unit will inform the user if the LT-3120 handset is not properly connected to the LT-4110 Control Unit. A BAM alert will be activated (Lost handset).

NOTE: The LT-3120 Handset must be operated together with the LT-3121 Cradle, for the off-hook detection circuit to work. The LT-3121 Cradle is described in *LT-3121 Cradle* on page 10.

LT-3121 Cradle

The LT-3121 Cradle is used together with the LT-3120 Handset. The LT-3121 Cradle should be mounted next to the LT-4110 Control Unit, supporting the LT-3120 Handset. The LT-3121 Cradle specifications are available in *App. G - Specifications* on page 133.

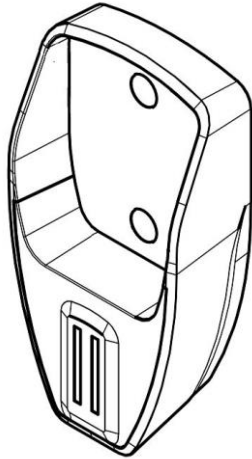

Figure 9: LT-3121 Cradle (front view).

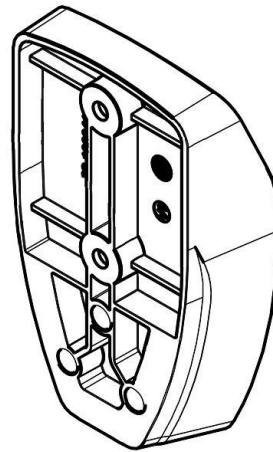

Figure 8: LT-3121 Cradle (backside view)

IMPORTANT: The LT-3121 Cradle contains a magnet, to hold on to the LT-3120 Handset. Make sure that other electronic equipment is installed in a distance respecting the compass safe distance of 1.4 m (4.6 ft).

An outline drawing for the LT-3121 Cradle is available in *App. O - Outline Drawing: LT-3121 Cradle* on page 141.

LT-4130 Antenna Unit

The LT-4130 Antenna Unit is designed for outdoor mounting and connected to the LT-4110 Control Unit via a coaxial cable. The LT-4130 Antenna Unit specifications are available in *App. G - Specifications* on page 133. The LT-4130 Antenna Unit has an N connector (female) mounted, centered at the bottom of the antenna.

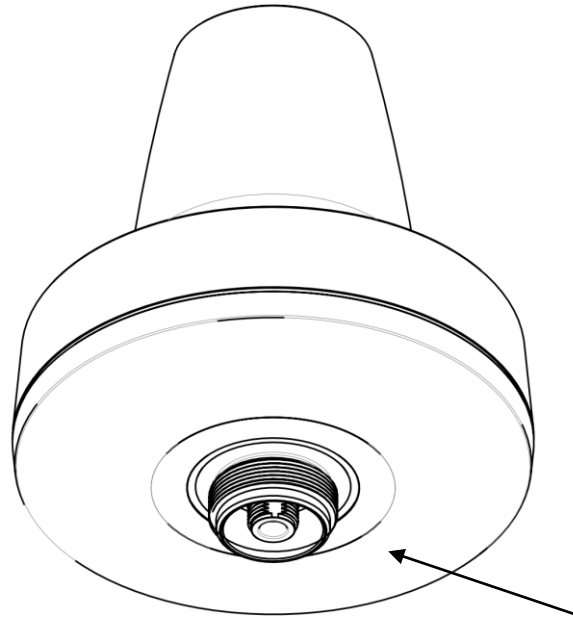

Figure 10: LT-4130 Antenna Unit.

The LT-4130 Antenna Unit has an N connector (female) at the bottom side of the unit.

Mounting and installation considerations:

- Mount the unit vertically (with the N connector pointing down)
- Mount the unit with free line of sight to the Iridium® and GNSS satellites. Make sure that the unit can receive signals from the Iridium® and GNSS satellites (satellite reception information is available in the LT-4110 Control Unit user interface display, see Figure 36 on page 39)
- Mount the unit on a rigid structure with a minimum of exposure to vibration and shock
- Mount the unit using either the Bracket Mount or Pole Mount provided by Lars Thrane A/S
- Mount the unit outdoor with an ambient temperature between -40°C to +55°C (-40°F to +131°F)
- Mount the unit with a minimum angle of 10 degrees towards a radar antenna (above or below) and keep a minimum distance of 2.5 m (8 ft)
- Mount the unit at least 1 m. (3 ft.) away from radio transmitting antennas (VHF, UHF, MF-HF)
- Mount the unit away from Inmarsat and transmitting VSAT antennas

In order to avoid breaking the LT-4130 Antenna Unit N-connector (female), it is important not to use tooling when connecting and fastening the coaxial cable N-connector (male) to the antenna unit. The coaxial cable N-connector thread nut must be fastened by hand only.



Figure 11: Connecting coaxial cable N-connector to the LT-4130 Antenna Unit

IMPORTANT: Maximum allowed torque is 2 Nm when connecting the coaxial cable N-connector (male) to the N-connector (female) of the LT-4130 Antenna Unit. No tooling must be used for fastening the coaxial cable thread nut as illustrated in Figure 11 above.

The LT-4130 Antenna Unit has a hazard warning label attached to the radome as illustrated in Figure 12.

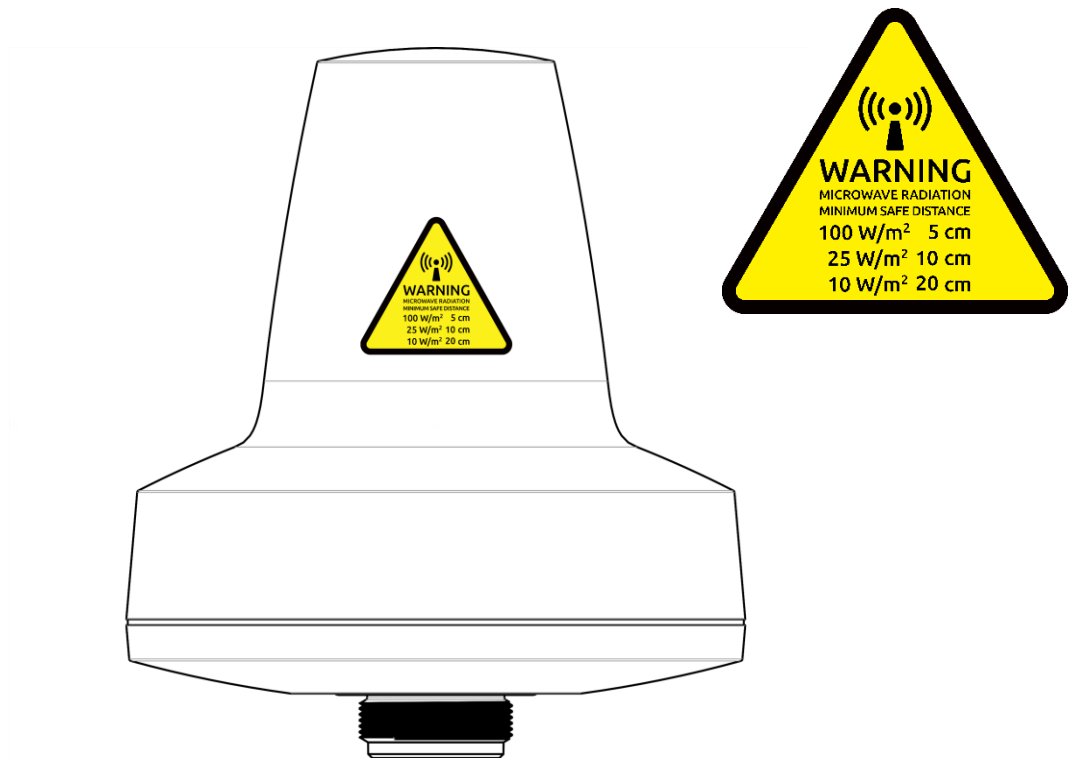

Figure 12: LT-4130 Antenna Unit (incl. warning label)

WARNING: The safety distance from the LT-4130 Antenna Unit, is 0.2 m (0.7 ft), to comply with the regional regulations.

IMPORTANT: Due to the adjacency of the Iridium and Inmarsat frequency bands, the LT-4130 Antenna Unit may not co-operate in the proximity of an active Inmarsat antenna unit, see *Coexisting with Inmarsat L-band* on page 18.

The LT-4130 Antenna Unit must be installed outside the radar main beam. Typically, this is in the order of 10 degrees. To avoid near field antenna coupling, a minimum distance of 2.5 m (6 ft) between the radar antenna and the LT-4130 Antenna Unit must be obeyed. Figure 13 is illustrating how the LT-4130 Antenna Unit should be mounted to avoid interference from radars.

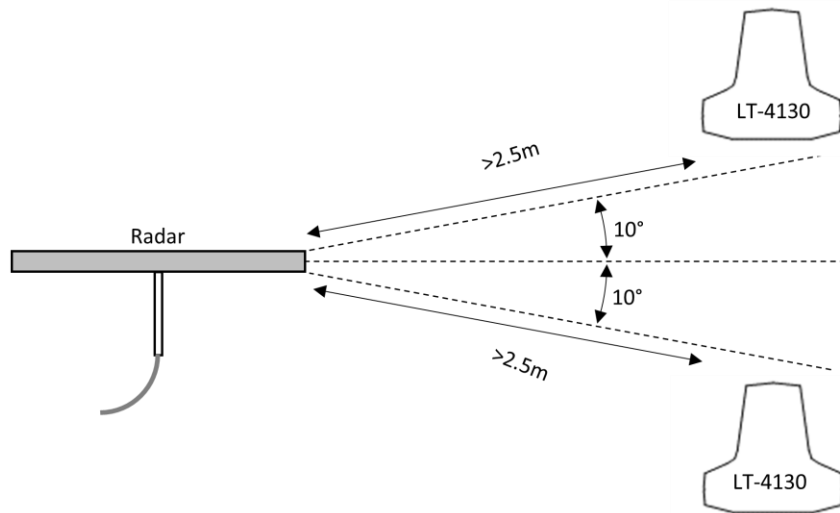

Figure 13: LT-4130 Antenna Unit – Avoid Radar Beam

IMPORTANT: Failing to obey the specified installation conditions will void the warranty. However, depending on the specific radar frequency and power level, the separation distance between the radar and the LT-4130 Antenna Unit may be reduced, with no impact on the antenna performance. The performance of the LT-4130 Antenna Unit should be validated when the LT-4100 system is installed.

The LT-4130 Antenna Unit must be mounted minimum 1 m from MF-HF, VHF, and UHF antennas.

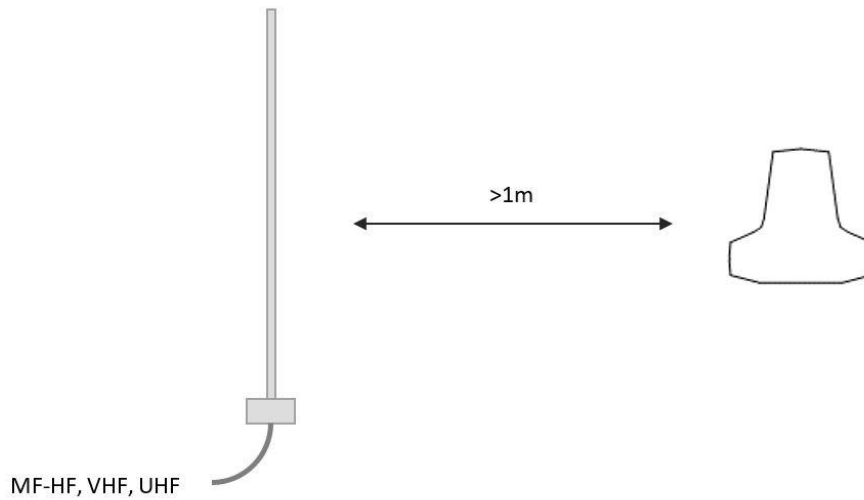

Figure 14: LT-4130 Antenna Unit - Separation to MF-HF, VHF, and UHF antennas.

NOTE: The LT-4130 Antenna Unit must be installed with a 360° clear view of the sky. However, minor obstructions such as a mast will not degrade the antenna performance severely, if a separation distance larger than 15 times the diameter of the obstruction is kept.

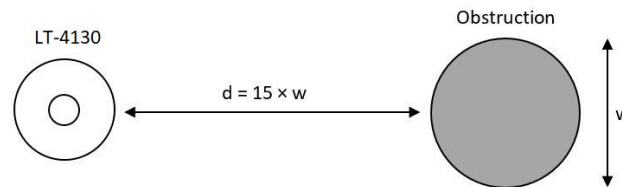

Figure 15: LT-4130 Antenna Unit – (separation distance to minor obstructions)

The LT-4130 Antenna Unit must be mounted using one of the mounts listed in *Mounts* on page 4

The LT-4130 Antenna Unit should be mounted with free line of sight to the Iridium satellites for best possible performance. The best location will typically be at the top of the lantern mast, where there are no obstructions blocking the Iridium satellite link. The LT-4130 Antenna Unit is designed to maintain a communication link to the Iridium satellites in all weather conditions, see Table 2.

Extreme Ship Motion Values & Clear View Angles Below the Horizontal Plan			
Motion Direction	Maximum Amplitude	Iridium Satellite Acq.	Clear View Angle Below the Horizontal Plan
Roll	±30°	+8°	-22°
Pitch	±10°	+8°	-2°

Table 2: LT-4130 AU Roll and Pitch Clear View Angles (below the horizontal plan)

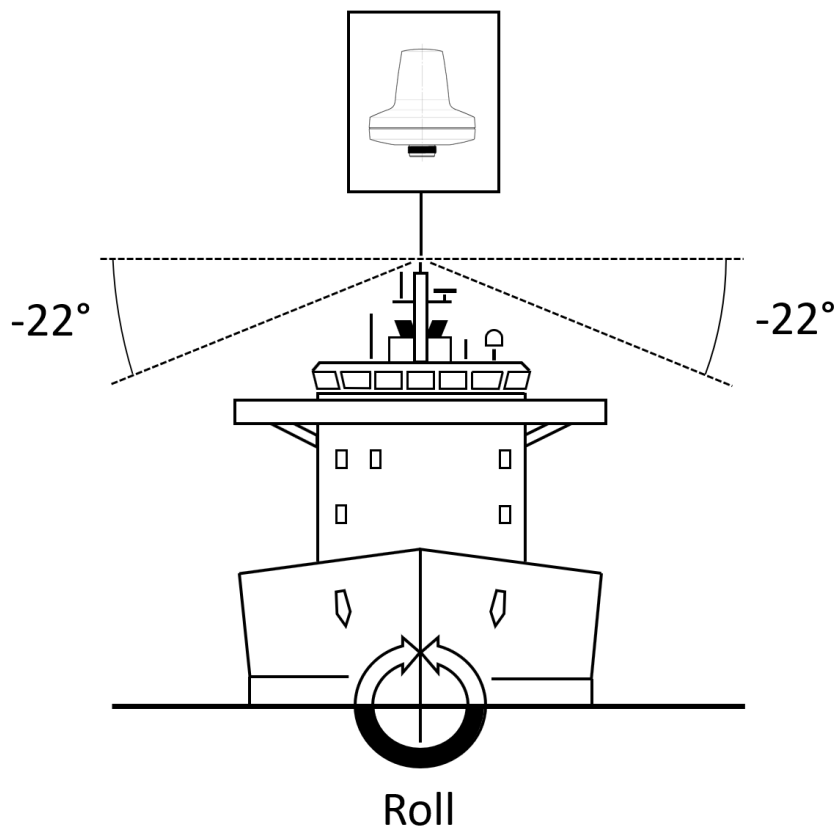

Figure 16: LT-4130 AU Installation (roll: clear view angle below the horizontal plan)

NOTE: The LT-4130 Antenna Unit should be mounted with a -22° clear view angle below the horizontal plan (port and starboard directions), where no obstructions block the Iridium satellite signal, to maintain full functionality under extreme roll conditions. Also, the upper hemisphere should be without any blockages to the Iridium satellites.

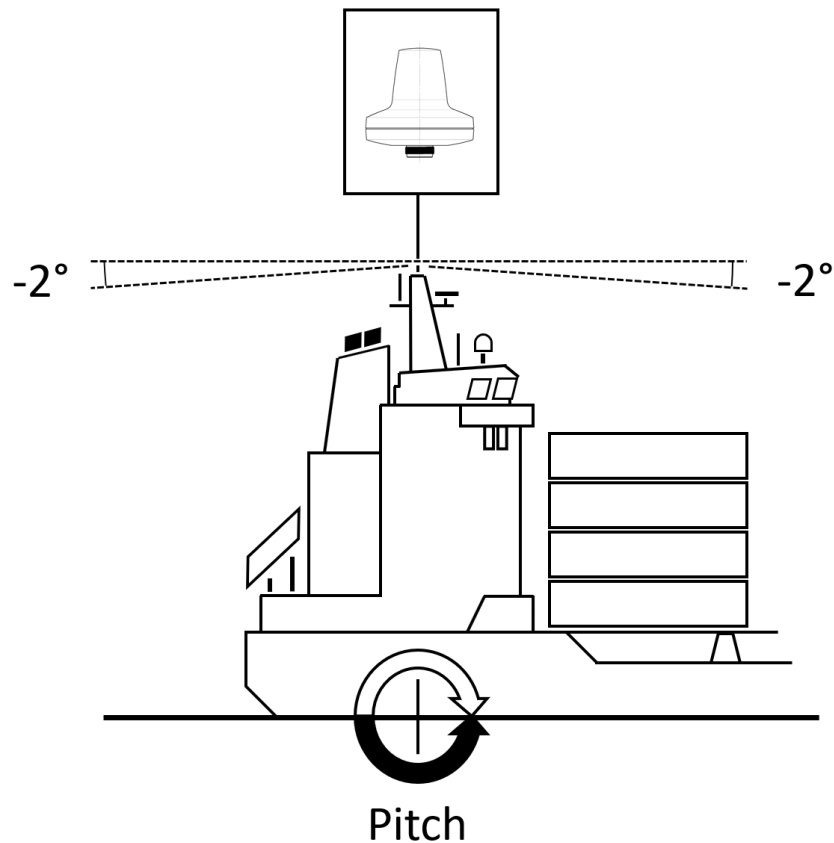

Figure 17: LT-4130 AU Installation (pitch: clear view angle below the horizontal plan)

NOTE: The LT-4130 Antenna Unit must be mounted with a -2° clear view angle below the horizontal plan (fore and after directions), where no obstructions must block the Iridium satellite signal, to maintain full functionality under extreme pitch conditions. Also, the upper hemisphere must be without any blockages to the Iridium satellites.

IMPORTANT: For best possible performance of the LT-4100 system, the LT-4130 Antenna Unit must have free line of sight to the Iridium satellites as illustrated in Figure 16 and in Figure 17 (clear view angle below the horizontal plan). To have the best possible performance obstructions should be below the marked lines of these two illustrative figures.

Coexisting with Inmarsat L-band

It is possible to install the LT-4100 system onboard a vessel that already has Inmarsat C equipment installed.

It is important to note that the LT-4130 Antenna Unit must be mounted below the Inmarsat C antenna with a minimum distance of 1 m and below an angle of minimum 15° when coexistence is required.

Practical use of the LT-4100 system during Alpha and Beta Sea trials, installed onboard vessels with Inmarsat equipment, has not revealed any degradation in system performance.

Survival distances:

Mount the LT-4130 Antenna Unit at a minimum distance of 1 m from an Inmarsat C antenna.

Mount the LT-4130 Antenna Unit at a minimum distance of 3 m from an Inmarsat Fleet Broadband antenna.

Pole Mount (1.5" pipe, Ø38.8mm), Antenna Unit

The Pole Mount (1.5" pipe, Ø38.8mm), Antenna Unit is illustrated in Figure 18 to Figure 20.

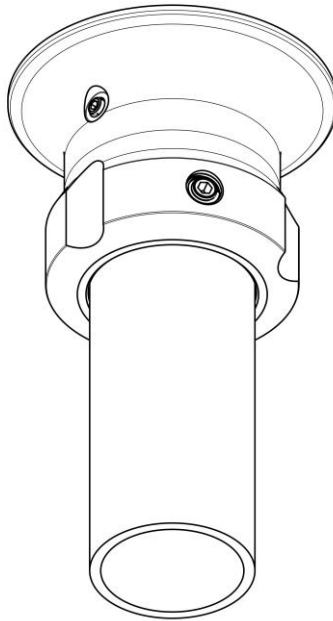

Figure 18: Pole Mount (1.5" pipe), Antenna Unit.

Pole mount installation procedure:

1. Feed the coaxial cable through the pole mount
2. Fasten the coaxial cable to the LT-4130 Antenna Unit (N connector)
3. Apply self-vulcanic tape on the N connector and cable to protect against saltwater and corrosion
4. Screw the pole mount (clockwise) on the LT-4130 Antenna Unit, and fasten the antenna lock pinot screw, as illustrated in Figure 20 (max torque = 1.2 Nm)
5. The LT-4130 Antenna Unit and pole mount can now be mounted on the 2.0" pipe. Fasten the three pole lock pinot screws, as illustrated in Figure 19 (max torque = 4.5 Nm)

NOTE: Remember to fasten the antenna lock pinot screw (1.2 Nm) after the pole mount and antenna unit have been screwed together.

NOTE: Remember to fasten the antenna lock pinot screw (1.2 Nm) after the pole mount and antenna unit have been screwed together. The Pole Mount (1.5" pipe), Antenna Unit interfaces to a pipe of maximum 1.5" (38.8 mm), measured outer diameter.

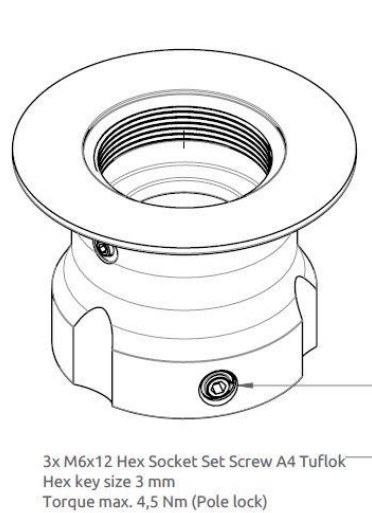

Figure 19: Pole Mount (1.5" pipe), Antenna Unit.

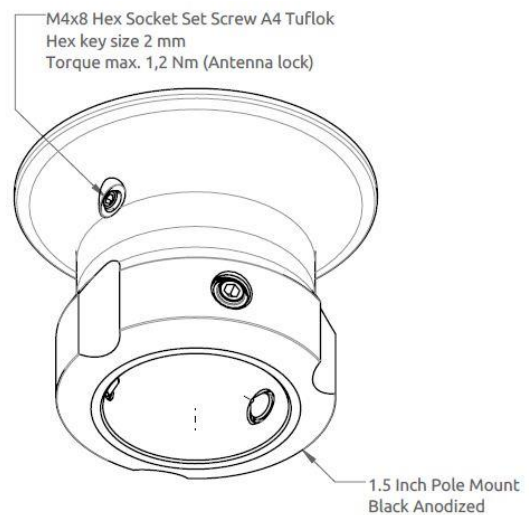

Figure 20: Pole Mount (1.5" pipe), Antenna Unit.

NOTE:

The Pole Mount (1.5" pipe, 38.8mm), Antenna Unit only supports a 1.5" pipe. The pinot screws (antenna and pole lock) torques are specified in Figure 19 and Figure 20. The pole mount is made of milled aluminum (anodized). The pinot screws are made of A4 stainless steel.

Pole Mount (2.0" pipe, Ø53.0mm), Antenna Unit

The Pole Mount (2.0" pipe, Ø53.0mm), Antenna Unit is illustrated in Figure 21 to Figure 23.

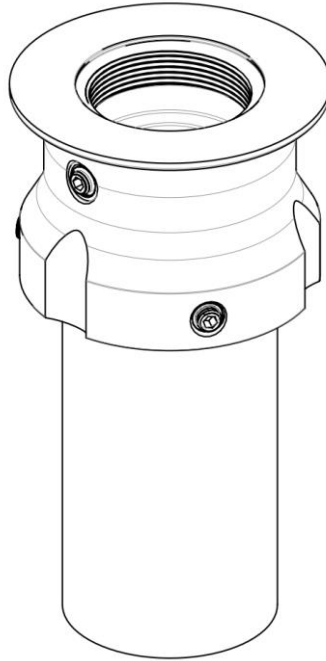

*Figure 21: Pole Mount (2.0" pipe),
Antenna Unit.*

Pole mount installation procedure:

6. Feed the coaxial cable through the pole mount
7. Fasten the coaxial cable to the LT-4130 Antenna Unit (N connector)
8. Apply self-vulcanic tape on the N connector and cable to protect against saltwater and corrosion
9. Screw the pole mount (clockwise) on the LT-4130 Antenna Unit, and fasten the antenna lock pinot screw, as illustrated in Figure 23 (max torque = 1.2 Nm)
10. The LT-4130 Antenna Unit and pole mount can now be mounted on the 2.0" pipe. Fasten the three pole lock pinot screws, as illustrated in Figure 22 (max torque = 4.5 Nm)

NOTE: Remember to fasten the antenna lock pinot screw (1.2 Nm) after the pole mount and antenna unit have been screwed together.

NOTE: The Pole Mount (2.0" pipe, Ø53.0mm), Antenna Unit interfaces to a pipe of maximum 2.0" (53.0 mm), measured outer diameter.

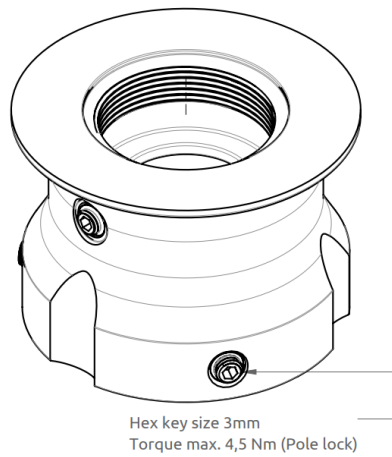

Figure 22: Pole Mount (2.0" pipe), Antenna Unit.

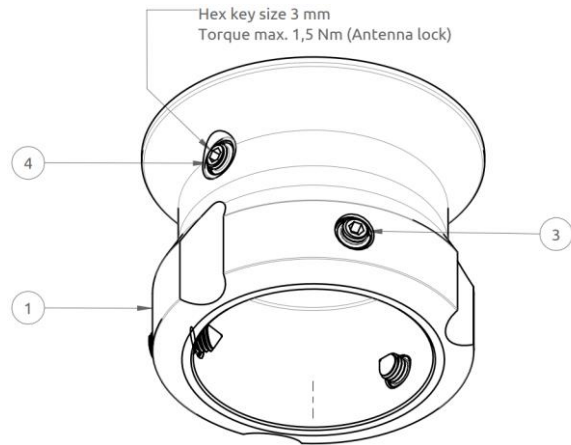

Figure 23: Pole Mount (2.0" pipe), Antenna Unit.

NOTE:

The Pole Mount (2.0" pipe, Ø53.0mm), Antenna Unit only supports a 2.0" pipe. The pinot screws (antenna and pole lock) torques are specified in Figure 22 and Figure 23. The pole mount is made of milled aluminum (anodized). The pinot screws are made of A4 stainless steel.

Interfaces

LT-4110 Control Unit

This section will describe all the external interfaces from the LT-4110 Control Unit.

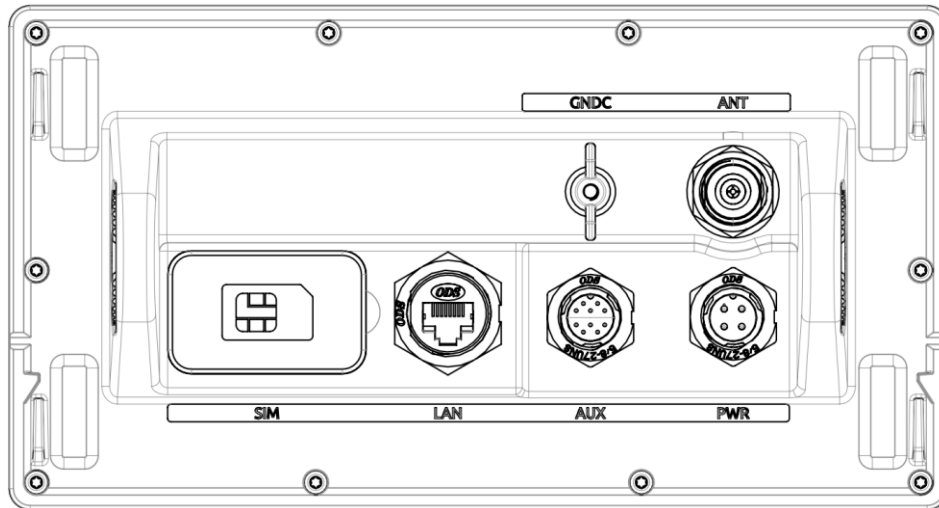

Figure 24: LT-4110 Control Unit (back view)

DC input (PWR)

The LT-4100 system is designed to be used on 12 VDC and 24 VDC power buses (nominal). External DC power to the LT-4100 system is provided by connecting the proprietary 91-102118 Power Cable, 3m - delivered by Lars Thrane A/S. The power connector is mounted on the back side of the LT-4110 Control Unit and marked 'PWR', see Figure 24.

The power source for the LT-4100 system must comply with the regulations and the associated standards, minimum is compliance to IEC 60945 (2002). When extending the power supply cables the positive (+) and the negative (-) must be installed closely together in order to keep the cable inductance low.

NOTE: Make sure to use a galvanic isolated power supply, see *Galvanic Isolated Power Supply* on page 37.

NOTE: The input voltage range is: 12-24 VDC (2.0-1.0A). The LT-4110 Control Unit DC input connector and circuit is protected and certified for Reverse Polarity Protection.

NOTE: A power connector (4-pole) is used for the LT-4110 Control Unit. This power connector requires the 91-102118 power cable, 3m from Lars Thrane A/S. Use only the 91-102118 power cable, 3m delivered by Lars Thrane A/S.

NOTE: The LT-3110S Control Unit must be connected to the power supply using a 15 A fuse or automatic circuit breaker. See *Galvanic Isolated Power Supply* on page 37.

Chassis ground (GNDC)

The chassis ground connector is placed on the back side of the LT-4110 Control Unit and marked with 'GNDC', see Figure 24 on page 23.

Certus SIM card (SIM)

The LT-4100 system requires a Certus SIM card to be operated with the Iridium® satellite services. The Certus SIM card must be bought from one of the official Iridium® Certus Service Providers. A list of Iridium® Certus Service Providers can be found at the Iridium® website: <https://www.iridium.com> (select 'Services', and hereafter 'Voice').

The Certus SIM card must be inserted in the LT-4110 Control Unit behind the rubber dust cover. Make sure that the LT-4110 Control Unit is powered off before opening the rubber dust cover. When the Certus SIM card is properly inserted in the slot, and the rubber dust cover is secured, the LT-4110 Control Unit can be powered up. The rubber dust cover is illustrated in Figure 24 on page 23 and marked with 'SIM'.

The following procedure must be followed when inserting, replacing, or removing the SIM card:

1. Turn off the power to the LT-4110 Control Unit
2. Remove the rubber dust cover on the back side of the LT-4110 Control Unit
3. Slide the SIM card holder as illustrated with the arrows on the PCB print, to unlock
4. Open the SIM card holder and insert or remove the Certus SIM card
5. Close the SIM card holder
6. Slide the SIM card holder as illustrated with the arrows on the PCB (opposite direction), to lock
7. Re-insert the rubber dust cover
8. Turn on power to the LT-4110 Control Unit

NOTE: The LT-4110 Control Unit must be powered off when inserting, changing, or removing the SIM card. The Certus SIM card is hidden behind the rubber dust cover on the back side of the LT-4110 Control Unit.

Figure 25 is showing an Certus SIM card. The format is Mini-SIM (2FF) 25 x 15 mm. The SIM card must be removed from the full-sized card carrier by breaking the Mini-SIM out. The full-sized card carrier contains the MSISDN number, while the SIM card itself contains the ICCID.

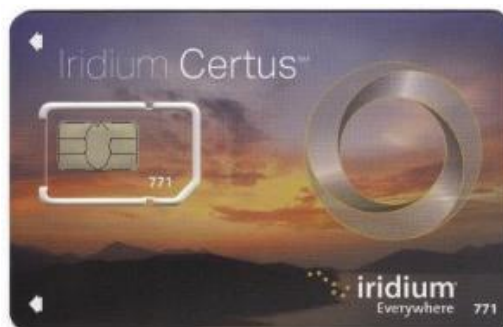

Figure 25: Certus SIM card

The Certus SIM card will be delivered from the Iridium Service Provider (ISP) together with the essential information:

- MSISDN numbers (the Iridium voice number)
- ICCID

Ethernet RJ45 (LAN)

The LT-4110 Control Unit has an Ethernet LAN (RJ-45) interface, currently supporting service & maintenance. The Ethernet interface must be used to access the built-in web server, which is further described in *Web server* on page 86.

The LT-4110 Control Unit will automatically request and obtain an IP address when connected to a Local Area Network (LAN) with a DHCP server (e.g. a router). If connecting the LT-4110 Control Unit directly to a PC, the two will automatically negotiate an IPv4 Link-Local address. The current IP address can be found in the user interface display (Menu -> System -> Network: IP Address).

Auxiliary (AUX)

The auxiliary connector is a 10-pin connector (male) mounted on the backside of the LT-4110 Control Unit as illustrated in Figure 24 on page 23 and marked with ‘AUX’. The auxiliary connector supports the following interfaces.

- RS-422 serial interface
- 2 x Input/output (I/O)

The Auxiliary connector / cable pin out and wire designation are illustrated in Figure 26, Figure 27, and in Table 3.



Figure 26: AUX connector pin out



Figure 27: AUX cable pin out

Auxiliary (AUX) Cable		
Pin No.	Wire Color	Wire Designation
1	Black	External Ringer (ground)
2	Brown	External Ringer (output)
3	Red	RS422 Z (output) TxD-
4	Orange	RS422 Y (output) TxD+
5	Yellow	RS422 A (input) RxD+
6	Green	RS422 B (input) RxD-
7	Blue	Radio Silence (input)
8	Violet	Radio Silence (ground)
9	Gray	Not Used
10	White	RS422 C (ground)

Table 3: AUX Cable

NOTE: Use only the 91-100768 Auxiliary Cable, 3m delivered by Lars Thrane A/S for connecting to the AUX connector on the backside of the LT-4110 Control Unit. The Auxiliary Cable, 3m is an accessory part and must be acquired separately.

The LT-4110 Control Unit is supporting external ringer functionality on the Auxiliary (External I/O) interface, which can be configured from the web server, see *External – I/O* on page 109.

The LT-4110 Control Unit is supporting GNSS and BAM on the Auxiliary (RS-422) interface, which can be configured from the web server, see *GNSS and BAM* on page 110.

External Output and Input are further described on the next pages.

RS-422 Circuit Diagram (LT-4110 CU – Aux Connector)

Figure 28 shows the RS-422 circuit diagram used for the LT-4110 Control Unit (Aux connector).

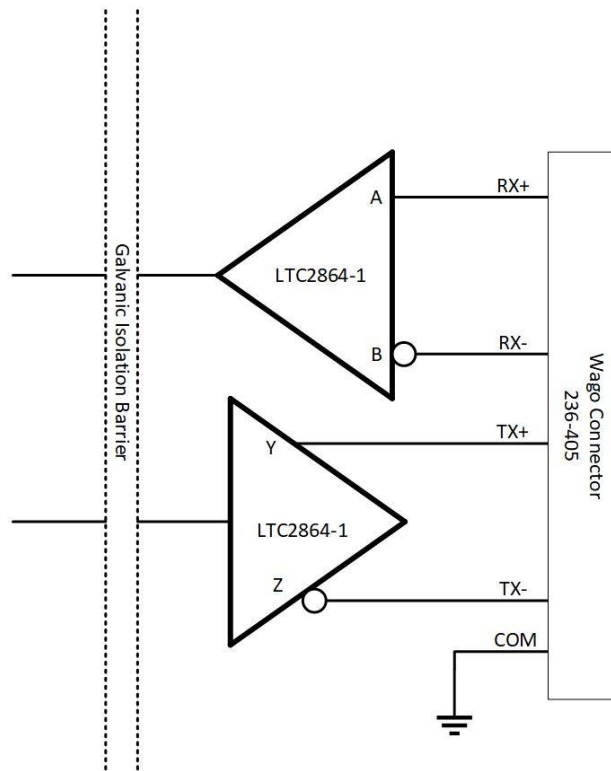

Figure 28: RS-422 Circuit Diagram for the LT-4110 CU

Interface Drive Capability as a Talker and Listener

- A(Rx+), B(Rx-), Y(Tx-): -60V to +60V
- Short circuit protected
- Galvanic isolated up to 1500V

External Output (External Ringer)

The LT-4100 system supports connection of an external speaker for incoming call notifications. Connection of the external speaker must be completed as illustrated in Figure 29, incl. a relay. The maximum voltage and current for the relay are illustrated in the figure. Aux Cable Pin 2 External Output (Pin2) and External Output (Pin1) designation and wire colors are listed in Table 3 on page 27.

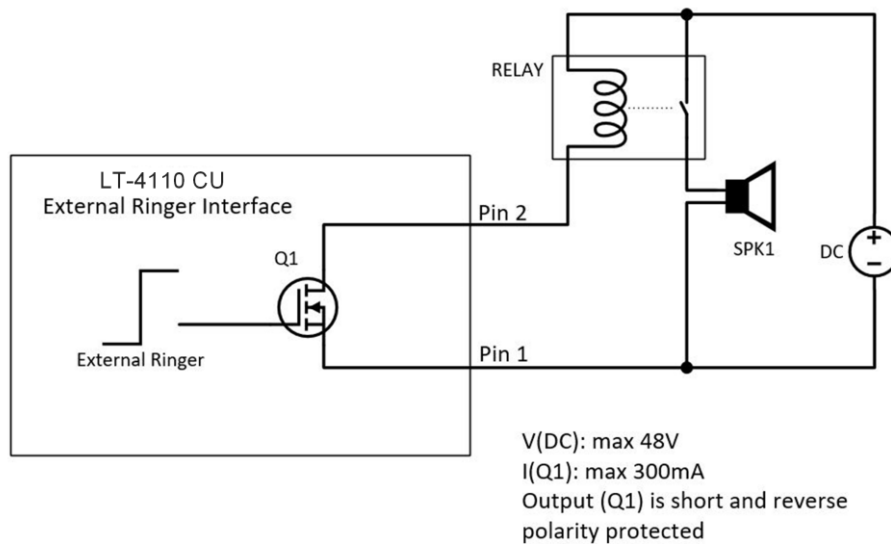

Figure 29: External Ringer diagram

NOTE: The External Ringer functionality must be configured in the web server, Configuration – External I/O, described in *External – I/O* on page 109.

External Input

The LT-4100 system is not supporting any functionality for the External I/O Input.

RS-422 (GNSS and BAM)

The LT-4100 system Auxiliary RS-422 (bi-directional) interface can be configured to support different functions. The following functions are supported:

- GNSS (see *GNSS sentences* on page 83)
- BAM (see *BAM sentences* page 84)

The RS-422 interface can be configured using the web server, see *GNSS and BAM* on page 110.

N Connector (ANT)

The LT-4110 Control Unit has a N Connector (male) for the interface to the LT-4130 Antenna Unit. The N Connector interface is providing data communication and power to the antenna unit over a coaxial cable. The N connector marked with 'ANT' is illustrated on Figure 3 on page 7.

NOTE: Do not connect or disconnect the antenna cable when the LT-4110 Control Unit is powered.

Bluetooth

The LT-4110 Control Unit has built in Bluetooth 4.0 with integrated antenna providing wireless communication between Bluetooth capable devices and the LT-4100 system.

Max Power: RF Tx Power 10 dBm

NOTE: The Bluetooth interface and pairing is described in *Bluetooth* on page 60.

NOTE: The built-in Bluetooth module and functionality will not be available in future production of the LT-4110 Control Unit due to manufacturer shortage and component obsolescence. In the display / GUI (MENU -> Settings -> Bluetooth) it can be verified if the Bluetooth module is mounted or not (the Bluetooth submenu will only be shown if the module is mounted).

LT-4130 Antenna Unit

The LT-4110 Control Unit and the LT-4130 Antenna Unit must be connected using a coaxial cable. Both the control unit and the antenna unit have a N connector (female) mounted. This section will specify the requirements to the coaxial cable. The RF and DC requirements are specified in Table 4 and Table 5.

RF Coaxial Cable Requirements	
Requirement	Specification
Cable impedance	50 Ω
Maximum signal loss	45 dB/100 m @ 1.5 GHz

Table 4: RF Coaxial Cable Requirements

In most cases it will be the DC resistance that will determine the maximum length of the coaxial cable. It is important to note that the input voltage of the control unit is important for the length of the coaxial cable that can be used.

DC Coaxial Cable Requirements	
Power Source	Maximum DC Resistance
12 VDC	1.7 Ω
24 VDC	5.5 Ω

Table 5: DC Coaxial Cable Requirements

NOTE: The DC coaxial cable resistance that is listed in Table 5 and used to calculate the maximum cable length is the sum of the DC inner conductor resistance and the DC outer conductor resistance. Some data sheets are not providing enough information about the DC resistance, in which cases, the cable manufacture must be approached to obtain this information.

Lars Thrane A/S has calculated the maximum allowed cable lengths with two coaxial cables as illustrated in Table 6. The two coaxial cables are FF195LSFROH (~RG-58) and FF400LSFROH (~RG-214/LMR400).

Maximum Coaxial Cable Length		
Cable Type	12 VDC Supply	24 VDC Supply
FF195LSFROH (4.9mm)	41 m	135 m
FF400LSFROH (10.3mm)	154 m	500 m

Table 6: Maximum coaxial cable length (cable examples)

The cable lengths calculated in Table 6 are obtained by using the maximum DC resistance [Ω] from Table 5 and compare these maximum DC requirements with the actual DC resistance [Ω/km] of the specific coaxial cables. The FF400LSFROH and FF195LSFROX total DC resistance numbers are listed in Table 7 on page 33.

The total DC resistance for the two cables (FF195LSFROH and FF400LSFROH) are:

Total DC Resistance (Inner and Outer Conductor)			
Cable Type	Inner Conductor DC Resistance [Ω /km]	Outer Conductor DC Resistance [Ω /km]	Total DC Resistance [Ω /km]
FF195LSFROH (4.9 mm)	24.9	15.8	40.7
FF400LSFROH (10.3 mm)	4.5	6.5	11

Table 7: Total DC resistance (cable examples)

IMPORTANT: If using a coaxial cable that is different to what is specified in this section (FF195LSFROH and FF400LSFROH), then verify that the RF and DC coaxial cable requirements (Table 4 and Table 5) are respected and calculate the maximum cable length as a function of the input voltage and the total DC resistance. Contact Lars Thrane A/S to get assistance on selection and acceptance of a specific coaxial cable.

NOTE: The LT-4110 Control Unit must be powered off when connecting or disconnecting the LT-4130 Antenna Unit.

Power Consumption

The LT-4100 system is powered from 12 VDC or 24 VDC power source. This section will provide power consumption details for maximum power consumption and typical average power.

Maximum

The LT-4100 system maximum power consumption is listed in Table 8. The maximum power consumption is calculated with activity on all interfaces.

24 VDC Maximum Power Consumption (Watt)	
System Unit	Power [W]
Total Power (maximum)	24

Table 8: Maximum Power Consumption (24 VDC input)

12 VDC Maximum Power Consumption (Watt)	
System Units	Power [W]
Total Power (maximum)	24

Table 9: Maximum Power Consumption (12 VDC input)

The coaxial cable length is an adding factor to the total power consumption of the system. A short coaxial cable will add approximately ~0 W to the total power consumption. The supported coaxial cable lengths for the LT-4100 system are described in *LT-4130 Antenna Unit* on page 32.

DC Isolation Resistance and Chassis Ground

The LT-4100 system must be installed properly with respect to DC isolation resistance and chassis ground. Wrong installations can lead to DC isolation issues (low Ohm meter measuring) on board the vessel and equipment damages. This section will provide details about installation precautions, which must be followed.

LT-4110 Control Unit (back view) with an upscaled power connector are illustrated in Figure 30. The Chassis ground (GNDC) must be connected sufficiently to the vessel ground. 91-102218 Power Cable, 3m must be used to connect the LT-4110 Control Unit to the vessel 12 or 24 VDC power source. DC isolation resistance measured on a disconnected LT-4110 Control Unit between GNDC and VDC (-) > 50 MΩ.

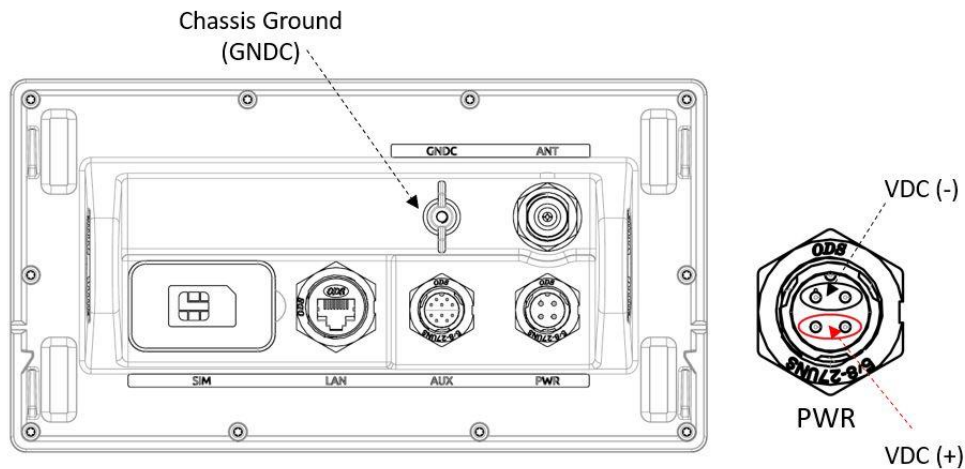

Figure 30: LT-4110 Control Unit (VDC(+), VDC(-), and GNDC)

The LT-4130 Antenna Unit (bottom view) is illustrated in Figure 31. Chassis ground (GNDC) on the LT-4130 Antenna Unit is defined as the mechanics (connected to the mounts).

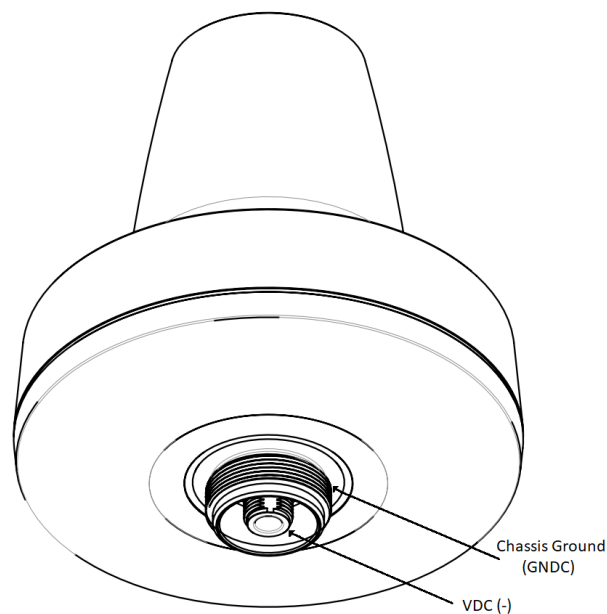

Figure 31: LT-4130 Antenna Unit (VDC(+), VDC(-), and GNDC)

DC isolation resistance measured on a disconnected LT-4130 Antenna Unit between GNDC and VDC (-) > 50 MΩ. VDC (-) and VDC (+) is respectfully the N connector thread and the N connector center conductor. Figure 32 is illustrating the LT-4100 system consisting of LT-4110 Control Unit, LT-4130 Antenna Unit, and the coaxial cable connecting these two units.

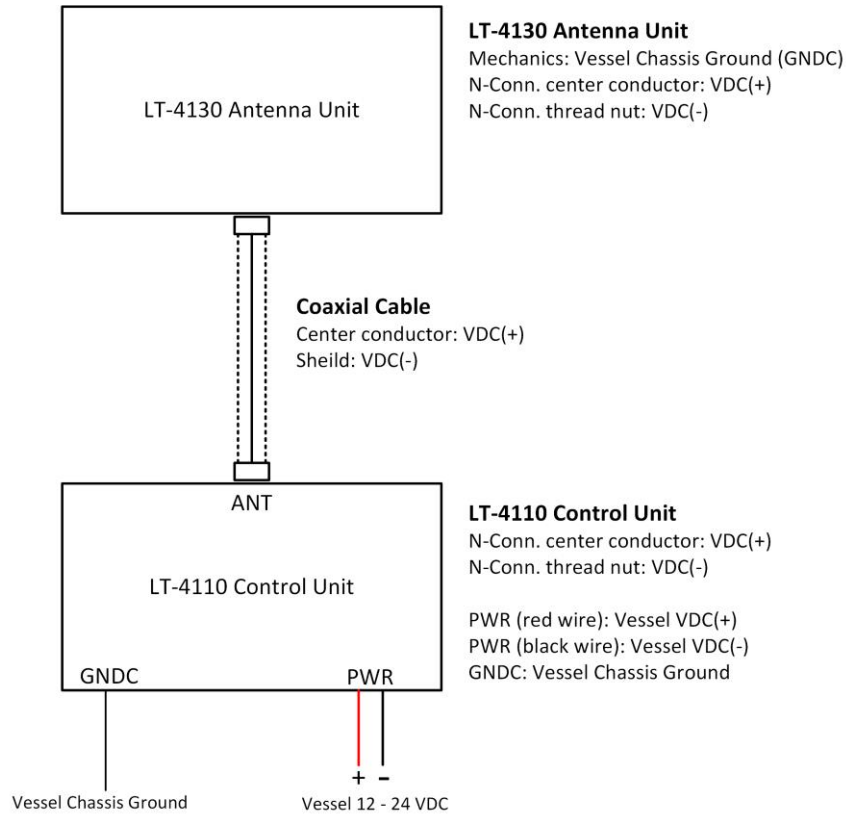

Figure 32: Definitions of VDC (+), VDC (-), and GNDC

It is important that the coaxial cable, connected to both the LT-4110 Control Unit and LT-4130 Antenna Unit, is not grounded in any of the ends. Do not connect the coaxial cable shield to vessel ground. The coaxial cable N connector must only be connected directly to the N connector of the two units.

NOTE: Make sure that the LT-4130 Antenna Unit is connected sufficiently to vessel ground. Also, make sure that the N connector on the LT-4130 Antenna Unit, VDC (-) is not connected to the LT-4130 Antenna Unit mechanics, GNDC. It is important to adhere to this requirement so as not to get a bad DC isolation resistance.

Galvanic Isolated Power Supply

Use an IEC 60945 approved AC/DC or DC/DC galvanic isolated power supply for the LT-4100 system (LT-4110 Control Unit). The galvanic isolated power supply must be used to protect the LT-4100 system. A 15A external fuse must be used for both AC/DC and DC/DC power supply units as seen on Figure 33 and Figure 34.

AC/DC Galvanic Isolated Power Supply

Connection of an AC/DC galvanic isolated power supply is illustrated in Figure 33.

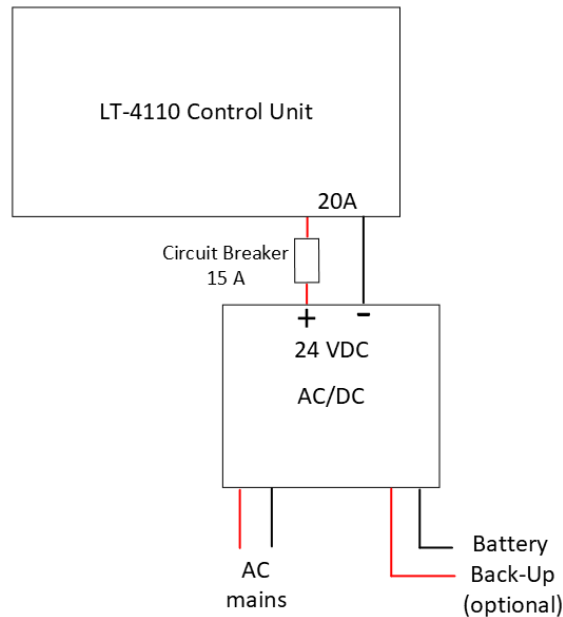

Figure 33: AC/DC Galvanic Isolated Power Supply

DC/DC Galvanic Isolated Power Supply

Connection of a DC/DC galvanic isolated power supply is illustrated in Figure 34.

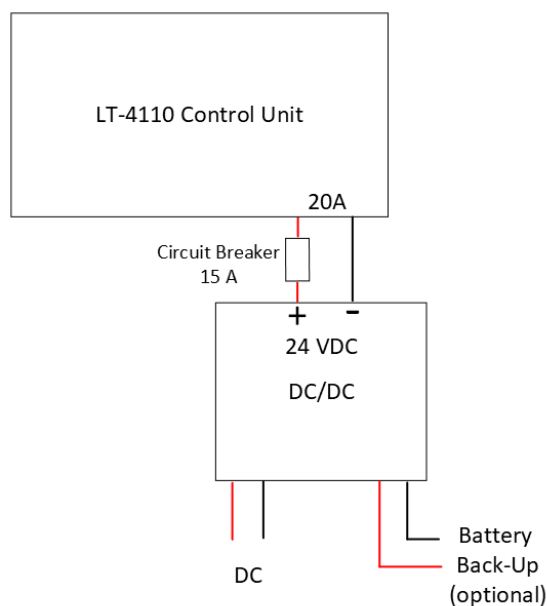

Figure 34: DC/DC Galvanic Isolated Power Supply

User Interface (UI)

The LT-4100 system is controlled from the LT-4110 Control Unit, which is the interface for operating and configuring the system. The control unit has a 4.3" TFT-LCD display, supporting day and night modes. The layout of the display and buttons is illustrated in Figure 35.

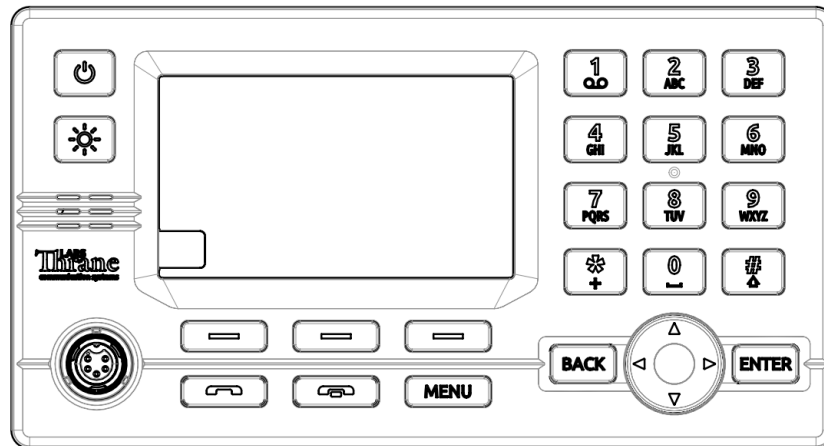

Figure 35: Control Unit (front view) – user interface display and buttons.

The control unit buttons, function and features, are described in the following groups:

- **Power button:** The power button can power off the system by pressing the button for 5 seconds. A pop-up box will show the action, and a counter will count down until the system is powered off. To Turn the system back on press and hold the power button.
- **Brightness button:** The brightness button has two functions – change of brightness level and change of display mode (day and night). When changing the brightness level, the keypad backlight will be changed as well. Short press (< 1 s); brightness level will change between 7 levels. Long press (≥ 1 s); will change display mode. The display brightness level and display mode can be changed from the UI menu as well (Menu -> Settings -> Display).
- **Off-hook button:** The button is illustrated with a green colored handset. The function of the off-hook button is to activate a call, if the dialled number is available in the display or a contact is selected in the Contacts or Call History. The off-hook button can also be used to accept an incoming call. The alternative to use the off-hook button is to lift the handset out of the cradle. If the off-hook button is used and the handset remain in the cradle, the phone audio will be available in the control unit speaker. The microphone is muted, if the handset remains in the cradle - indicated with an icon in the status bar.
- **On-hook button:** The button is illustrated with a red colored handset. Pressing the on-hook button will terminate an active call.
- **MENU / BAM button:** The MENU button is used to open the main menu. The BACK, Navigation (arrows), and ENTER buttons are used to navigate in the menu. Press the MENU button to exit the menu from anywhere in the menu tree (instead of multiple BACK button presses). Long press (> 1 s) the MENU / BAM button and the BAM Alert List will be shown.
- **Soft keys buttons:** Three soft keys are available in the bottom of the display. The soft keys are used for different purposes and their functions will change in the operation modes of the system.
- **Navigation buttons:** The navigation buttons (BACK, arrows, and ENTER) are used for navigation purposes in the menu layout. In context of user input or when making selections, the BACK button will erase input or cancel editing respectfully, the ENTER button will end input or apply selection

respectfully. The arrow buttons can be used to change brightness level if the brightness button has activated the brightness bar.

- Numeric Keypad buttons:** The numeric keypad buttons, the '*' button, and the '+' button can be used for entering digits, letters and special characters. Depending on context, pressing one button in rapid succession (< 1s) will cycle through a selection of letters, digits and/or special characters (e.g. when entering a phone number, pressing the '*' character twice in succession will result in one '+' character and not two '*' characters). An icon in the status bar will show the current input mode, indicating which characters can be cycled - if any. In text mode, the '#' key is used to change between capital and lowercase letters.

Display

The display contains three sections as illustrated in Figure 36: Status bar, view area and soft keys.

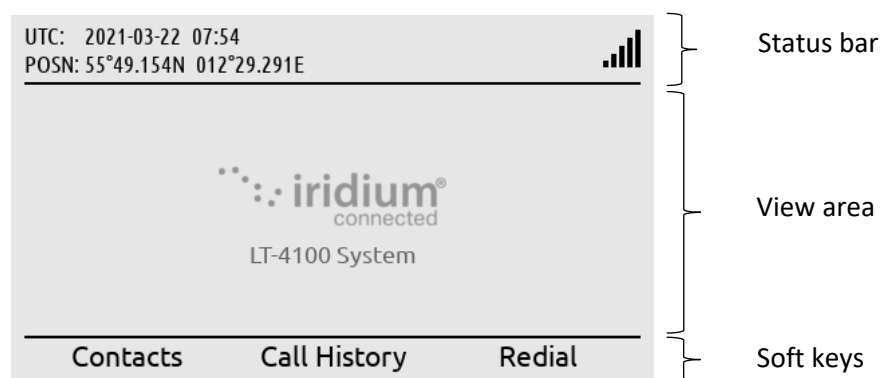

Figure 36: LT-4110 Control Unit - UI display sections

The essential system status and system notifications are shown in the status bar, which is always present.

The view area contains the active view. The active view is changed by navigating the UI using the MENU and navigation buttons. The text and function of the soft keys changes dynamically with the active view. The soft keys can also change without changing view depending on the activity in the active view.

The Recommended viewing distance is 68 cm, at which all data is readable under all light conditions.

The general level of the brightness can be varied through 7 steps from 5 cd/m² up to 560 cd/m² on white background in “Day mode”. The display also has a “Night mode” (inverted graphics) with additional 7 steps.

It has been verified through measurements that dense text information areas on black background emits light equivalent to 1 cd/m². All measurements through all light levels in the two modes demonstrates a minimum contrast level of 350:1.

The status bar has a dedicated section for presenting time and position and 7 slots for system status icons.

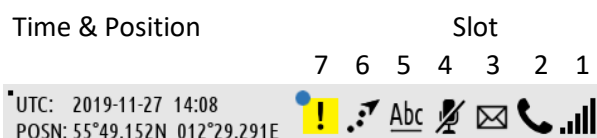

Figure 37: LT-4110 Control Unit - UI (status bar)

NOTE: The status bar contains a flashing square in the upper left corner to verify that the display never freezes, see Figure 37 above. The flashing square is always visible on the display.

Each slot shows the status of one function or group of functions. If a group of functions in a slot has more than one active icon, the slot will continuously take turn showing one icon at a time for a few seconds before cycling to the icon of the next function.





Network Status - Slot 1	
	The LT-4100 system has no satellite signal and is not registered on the Iridium® Network.
	The LT-4100 system has satellite signal = 0 and is registered on the Iridium® Network.
	The LT-4100 system has satellite signal = 1 and registered on the Iridium® Network.
	The LT-4100 system has satellite signal = 5 and registered on the Iridium® Network.

Table 10: LT-4110 Control Unit - UI network status





Iridium Service - Slot 2	
	Active voice call or off-hook mode.
	Voice service unavailable due to an unspecified error
	There is an active data connection.
	Data service unavailable due to an unspecified error

Table 11: LT-4110 Control Unit - UI Iridium service



Notifications - Slot 3	
	There are one or more missed calls.
	There are one or more voicemail messages.

Table 12: LT-4110 Control Unit - UI notifications

Audio - Slot 4	
	The microphone on the handset is muted.

Table 15: LT-4110 Control Unit - UI audio





Input Mode - Slot 5	
	The numeric keypad can be used to enter a phone number or numeric number.
	The numeric keypad can be used to enter text. The first letter of a sentence will be in upper case.
	The numeric keypad can be used to enter text. All letters will be in lower case.
	The numeric keypad can be used to enter text. All letters will be in upper case.

Table 14: LT-4110 Control Unit - UI input mode

Miscellaneous Functions - Slot 6	
	A Bluetooth device is connected.

Table 13: LT-4110 Control Unit - UI miscellaneous functions







BAM Status - Slot 7	
	Active - unacknowledged warning
	Active - silenced warning
	Active - acknowledged warning
	Active - responsibility transferred warning
	Rectified - unacknowledged warning
	Active caution

Table 16: LT-4110 Control Unit - status bar (BAM status)

Menu System

The LT-4100 system’s main menu is accessed by pressing the MENU button on the keypad. The user will be presented with a layout as illustrated in Figure 38.

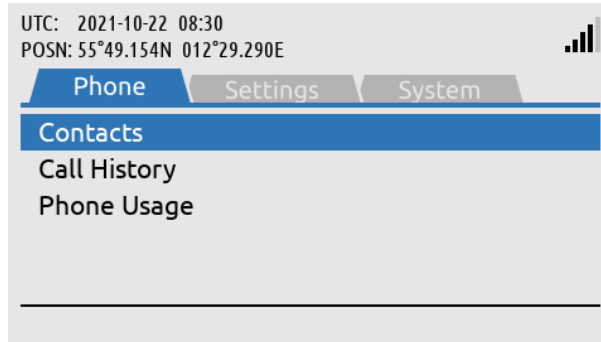
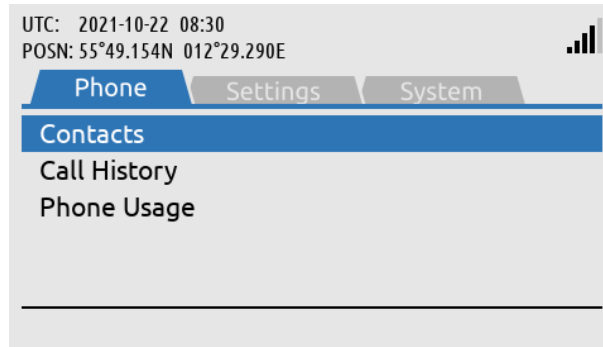

Figure 38: LT-4110 Control Unit - UI display (main menu).

The main menu is represented by three sub-menus: Phone, Settings, and System. The three sub-menus are listed in Table 17.

Sub-menus	Entries
Phone	Contacts Call History Phone Usage
Settings	Audio Display Date & Time Phone Setup Bluetooth IP Data Remote Access Reset Options
System	BAM Alerts Network SIP Phones GNSS Status Subscription System Info Power Supply

Table 17: LT-4110 Control Unit, sub-menu layout.



Phone submenu:
MENU -> Phone

Figure 39: Phone submenu

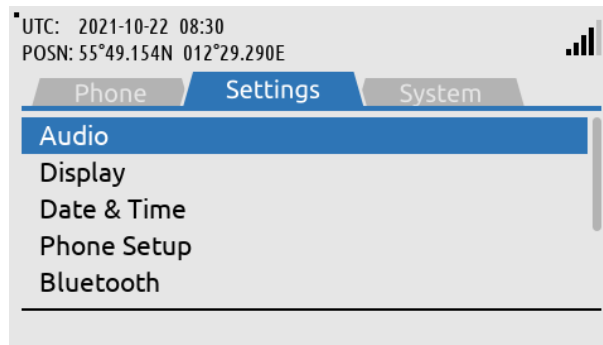

Phone submenu:
MENU -> Settings

Figure 40: Settings submenu

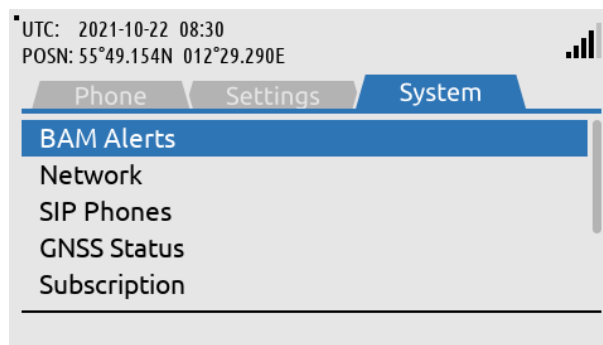

Settings submenu:
MENU -> System

Figure 41: System submenu

Activating the System

A few things must be completed before you can have an operational LT-4100 system on board your vessel. It is assumed that you have received the LT-4100 system from a Lars Thrane A/S distribution partner - this could be directly or indirectly. The Lars Thrane A/S distribution partner will be able to assist you with all the questions you might have to the product or service. The Lars Thrane A/S distribution partners are listed on the company's website: <https://www.thrane.eu>

The following steps are required for activating the LT-4100 system:

- Acquire a Certus SIM card and activate this

IMPORTANT: In order for the LT-4100 system to be deemed operational and ready for continuous service: i) it must be correctly installed per the specifications in the User & Installation Manual of the LT-4100 Satellite Communications System ("LT-4100 User & Installation Manual"), ii) the Iridium SIM card, which serves to evidence that a terminal has been subscribed to Iridium's Network, has been secured and correctly installed. The Iridium SIM card is at all times required for operation of the equipment and is a critical and indispensable part of the LT-4100 system. Without a valid Iridium SIM card correctly installed and continuously maintained in the inserted position in the LT-4110 Control Unit, pursuant to the instructions in the LT-4100 User & Installation Manual, the terminal is not operational and not ready and available for continuous use on any vessel.

Acquire a Certus SIM Card

A Certus SIM card must be used for activating a LT-4100 system. The Certus SIM card is described and illustrated in *Certus SIM card (SIM)* on page 25. The Certus SIM card may be acquired directly from your Lars Thrane A/S distribution partner or from an Iridium Certus Service Provider. The Certus SIM card must be inserted in the LT-4110 Control Unit before powering up the system.

Postpaid Voice Features

All Iridium Certus terminals can only be used with the standard postpaid voice service. The postpaid voice service features the ability to block calls either ingoing or outgoing, call forwarding, call forwarding when busy, call forwarding when there is no answer and call forwarding when the LT-4200 system is unreachable. Configuring and using these features is described in in *Supplementary services* on page 53.

Who's My Service Provider

Iridium has a website where they inform about the specific Service Provider (SP) who has activated the LT-4100 system (or any other Iridium activated product).

Use the following link: <https://www.iridium.com/who-is-my-sp/>

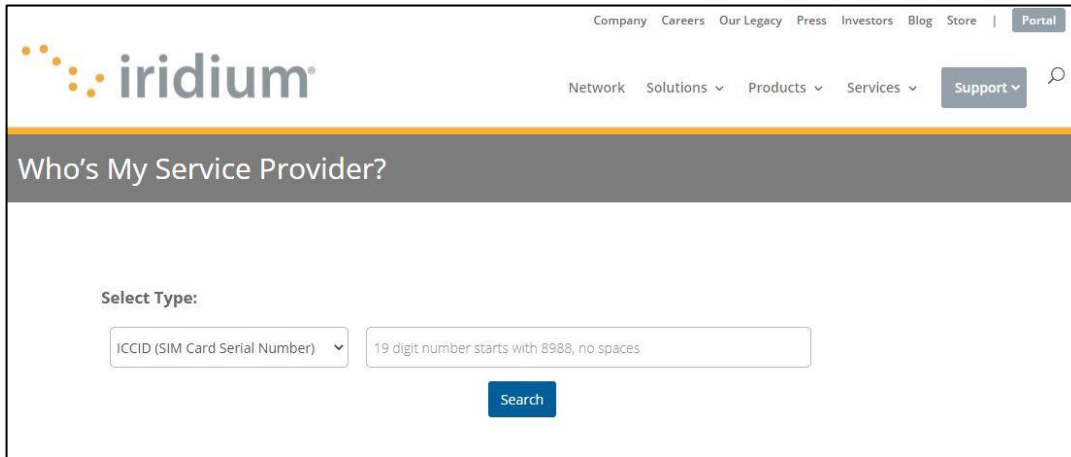

Figure 42: Iridium - Who's My Service Provider

You can use the following information:

- ICCID (SIM card serial number)
- MSISDN (Mobile Subscriber ISDN number)

NOTE: The Iridium Certus Service Provider (SP) must be contacted for any changes to the provisioning. 'Who's My Service Provider' will inform you where your LT-4100 system is provisioned.

Change of Hardware and Software

This section will provide some guidance and instructions on replacing system units or updating software.

Change of Hardware

This section will provide some guidance on replacing system units and what the user of the LT-4100 system should be aware of, see Table 18.

Change of Hardware		
Hardware	Procedure	Comments
LT-4110 Control Unit	The LT-4110 CU can be replaced by swapping the hardware. Remember the Certus SIM card from the 'old' LT-4110 CU.	All user data (contacts and call history) will be lost since the LT-4110 CU is the 'master' of the system.
LT-3120 Handset	Change hardware.	Test the new hardware.
LT-3121 Cradle		
LT-4130 Antenna Unit		
Certus SIM Card	The Certus SIM card can be replaced with a new Certus SIM card.	Only a Certus SIM card can be used in the LT-4100 system. Check status of the Certus SIM card with an Iridium Certus Service Provider.

Table 18: Change of Hardware in the LT-4100 system

Always remove the DC input power to the LT-4100 system when changing the hardware and system units.

NOTE: Changing the Certus SIM card may require involving of an Iridium Certus Service Provider (SP). For details of the Iridium Certus Service Provider (SP), see *Activating the System* on page 45.

Software Update

The LT-4100 system must be software updated by using the web server, configuration - software update, see *Software update* on page 116. Accessing the web server is described in *Accessing the built-in web server* on page 87. The software update procedure will automatically update all system units connected to the LT-4110 Control Unit. The Lars Thrane Image (LTI-file) e.g. LT-4100-v1.00R-00XX.lti will include all software components to all system units. All system units connected to the LT-4110 Control Unit will be upgraded or downgraded to be aligned with the LT-4110 Control Unit, which is the 'master' of the system. As soon as the software update procedure is started, the LT-4110 Control Unit window will indicate 'Software update in progress' as illustrated in Figure 43.

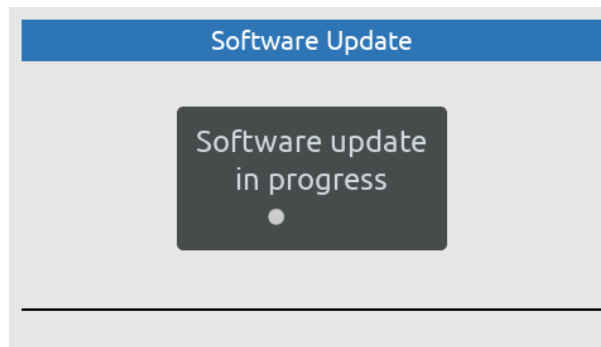

Figure 43: Software update

Once, the LT-4100 system has finalized the software update, the system will reboot.

NOTE: Please check the Lars Thrane A/S company website for newest available software for the LT-4100 system.

System Services

Voice Call

The LT-4100 system supports 2 x voice call via two voice lines (high-quality). The voice calls can be simultaneously active if they are run on different voice lines. The system can be set up to use one or two voice lines. The voice lines are configurable and can be set up to cover multiple phones. Any voice call to or from the LT-4100 system will generate a record in the Call History placed in the Phone submenu (MENU -> Phone -> Call History), see *System Submenus, Phone* on page 63.

The two voice line system enables the owner of the LT-4100 system to have two voice calls up at the same time from different phones. e.g., the bridge can have an active call, while the captain can have an active call simultaneously from his cabin. The two voice lines each have their own unique phone number and they function as two separate entities, with the user being able to configure SIP phones and the LT-4110 Control Unit for each or both lines. An example voice line configuration can be seen on Figure 44 below.

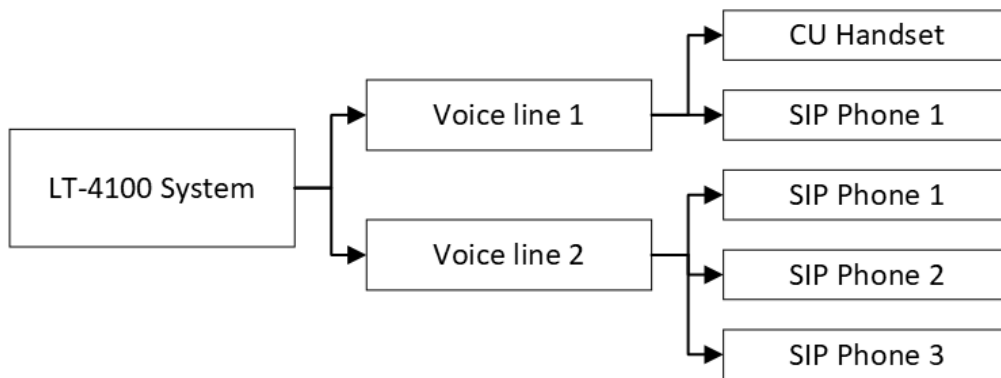

Figure 44: Example of voice line configuration

The system is per default set to choose voice line automatically and will choose line 1 per default when initiating MO calls, however this can be configured to either automatic or manual selection, as described in *System Submenus, Settings* on page 68.

External SIP Phones

The LT-4100 system is supporting connection of external SIP phones, up to 8 external SIP phones. The configuration of the SIP phones must be completed via the web server, see *Telephony* on page 106. Figure 45 is illustrating the connection of the external SIP phones. Connect the SIP phones directly to the LT-4110 Control Unit Ethernet (LAN port).

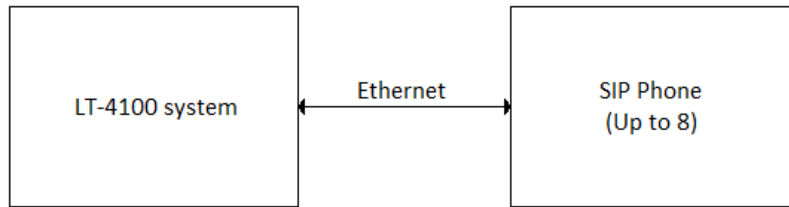
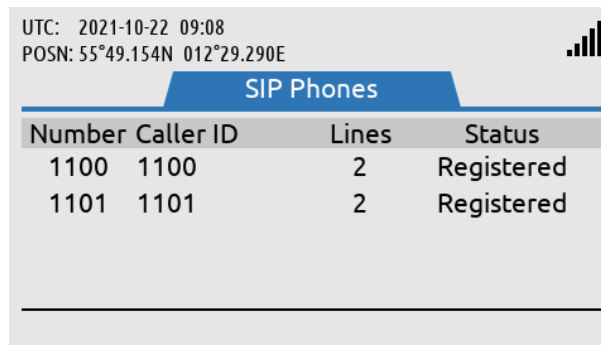

Figure 45: SIP phones

NOTE: The SIP phone might require a DHCP Server to get an IP address assigned. Depending on network setup, it might be needed to configure DHCP Server mode in the LT-4100 system.

The LT-4110 Control Unit UI display (MENU -> System -> SIP Phones) will provide a ‘live’ registration status of the SIP phones configured from the web server.



SIP Phones:
MENU -> System -> SIP
Phones

Figure 46: System Submenu (SIP Phones)

An active voice call to/from a SIP phone is not shown on the Control Unit on Certus, see Figure 47.

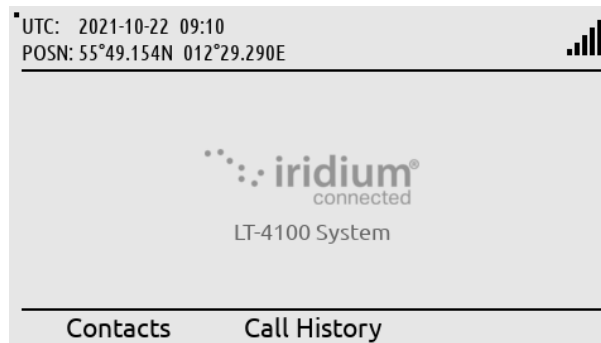

Figure 47: External SIP Voice Call

An incoming voice call taken by the SIP phone cannot be forwarded once it has been taken by any of the voice lines.

The LT-4100 system is supporting local calling between the SIP phones and the LT-3120 Handset. The number plan is illustrated in Table 19. The Caller ID is defined by the user, when configuring the SIP phones.

LT-4100S System Number Plan (local calls)		
Number	Caller ID	Comments
1000	LT-4100 User	LT-3120 Handset
1100	SIP Phone 1	
1101	SIP Phone 2	
1102	SIP Phone 3	
1103	SIP Phone 4	
1104	SIP Phone 5	
1105	SIP Phone 6	
1106	SIP Phone 7	
1107	SIP Phone 8	

External SIP voice call is not shown on the LT-4110 Idle screen.

Table 19: Number Plan (local calls)

NOTE: The LT-4100 system is supporting two outgoing satellite voice connections. A local call between two local users will not busy the Satellite voice connection.

Analogue Phone Adapter

The LT-4100 system is supporting connection of an external Analogue Phone Adapter (e.g. Grandstream). The number of POTS' phones (Plain Old Telephone System), which can be connected to the Analogue Phone Adapter, must be configured as SIP phones in the LT-4100 system, see configuration of SIP phones in *Web server, Telephony* on page 106. Connect the SIP phones directly to the LT-4110 Control Unit Ethernet (LAN port).

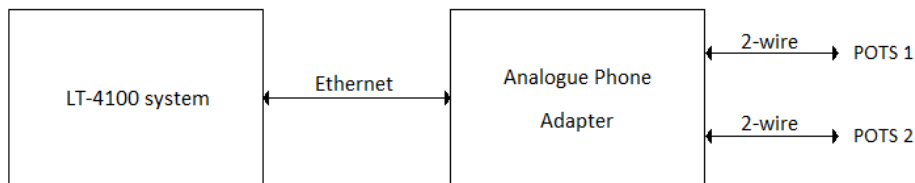

Figure 48: Analogue Phone Adapter

NOTE: The Analogue Phone Adapter might require a DHCP Server to get an IP address assigned. Depending on network setup, it might be needed to configure DHCP Server mode in the LT-4100 system.

The Analogue Phone Adapter (POTS phones) will be handled as SIP phones in the LT-4100 system. Therefore, carefully read the section describing the SIP phones in section *External SIP Phones* on page 50.

To provide some guidance for configuration of an Analogue Phone Adapter, the following description will outline some important steps for configuring an Analogue Phone Adapter.

Configuration of Grandstream HT802 Adapter (example):

If you would like to connect the Analogue Phone Adapter directly to the LT-4100 system, then it might help you to insert a passive switch between the LT-4100 system and the Analogue Phone Adapter, while completing the setup (to allow for an extra LAN port during configuration).

- Step 1: Connect the LT-4100 system, Analogue Phone Adapter, and PC using a passive switch
- Step 2: Login to the LT-4100 system web server. The IP address can be read from the display (MENU -> System -> Network: IP address)
- Step 3: Configure the LT-4100 system to 'DHCP Server' mode (depending on network setup) and configure the SIP phones (Password, and Caller ID)
- Step 4: The Analogue Phone Adapter will now have an IP address assigned. Connect a POTS phone to the Analogue Phone Adapter and use the IVR menu to read out the IP address (off hook handset and type '***' followed by '02'). Check the instructions provided for the Analogue Phone Adapter
- Step 5: Log in to the Analogue Phone Adapter and configure FXS PORT 1 and PORT 2 (Primary SIP Server, SIP User ID, Authenticate ID, Password, and Name)
- Step 6: The POTS phones should now be registered and ready to use (the passive switch can be removed).

Supplementary services

As described in *Postpaid Voice Features* on page 45, the LT-4100 system offers a list of voice call features. What they are and how they function is described in the following sections

Call Barring

The call barring feature allows the operator of the LT-4100 to block all incoming or all outgoing calls. To enable and disable this follow the instructions below

Outgoing Call barring

- Activate Dial ***33*<4 digit password>**
- Deactivate Dial ***34*<4 digit password>**
- Check status Dial ***33**

Incoming Call barring

- Activate Dial ***35*<4 digit password>**
- Deactivate Dial ***36*<4 digit password>**
- Check status Dial ***35**

NOTE: The default password is **0000**.

Call Forwarding

The LT-4100 system can be set up to forward all incoming calls based upon the interaction with the system. The call can be forwarded due to four reasons: Unconditional, Busy, No Answer, and Not Reachable. Configuring the system to one or more call forwarding states can be done as per using the codes listed in Table 20 below.

Call Forwarding				
Cause	Register	Activation	Deactivation	Check Status
Unconditional	*21*<number>	*21	*22	*23
Busy	*67*<number>	*67	*68	*69
No Answer	*61*<number>*<timeout>#	*61	*62	*63
Not Reachable	*24*<number>	*25	*26	*27

Table 20: Call Forwarding

To activate call forwarding the user must first register and then activate the specific call forwarding feature. To deactivate or check status use the call codes as per Table 20.

Data

This section describes the different ways the LT-4100 system can be set up to handle outgoing and incoming data. The section describes the concepts and effects of the user actions regarding Data. For further information on how to configure the system for data management, *Web server, Network* on page 91 and *IP Data* on page 105. The Data usage can be seen in the Phone Usage submenu in the Phone menu. This is shown in *System Submenus, Phone*. Note that the LT-4110 does not present the Data usage with 100% accuracy as e.g., a bad connection could force the system to resend data packets, which is not tracked in the Data usage list.

NOTE: The LT-4100 system has a built in DNS server which will cache user input, ensuring input is stored for down the line. Having an input DNS server reduces the user data stream, eventually reducing data cost.

Data activation

The LT-4100 system can be configured to either '*Always on*' or '*Manual start/stop*', this can either be done on the Web server as described in *Web server, IP Data* on page 105, or via the LT-4110 Control Unit as shown in *System Submenus, Settings*.

Always on

When the system is set to *Always on* the data stream will as the name suggests always be open for activity, and the system will be able to send data if need be and if permitted by the outgoing firewall / port forwarding rules.

Manual start/stop

When the system IP data stream is set to *Manual start/stop* the user has direct control of when data is allowed to be sent by the system. The user is able to control this directly via a '*Data start*' or '*Data stop*' soft key on the LT-4110 Control Unit, see Figure 49 and Figure 50 on page 54 and 55. The *Manual start/stop* setting gives the operator of the system more direct control over when data is transmitted from the system and will therefore be the more economical solution to outgoing IP data, as nothing is sent when the data stream is manually turned off.

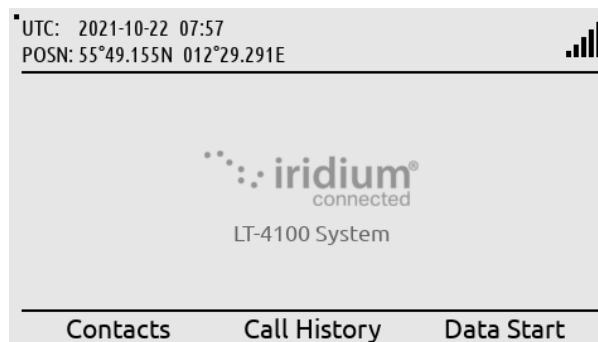

Figure 49: Manual data Start

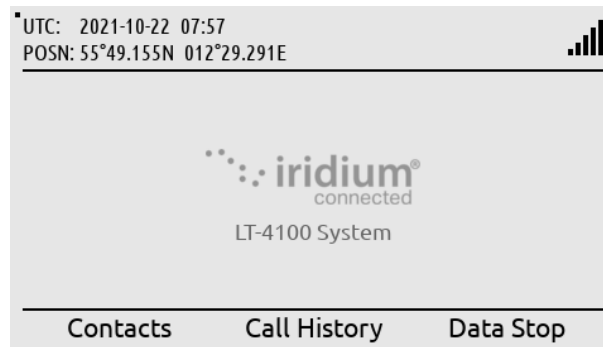

Figure 50: Manual data Stop

IMPORTANT: This configuration of the data stream only refers to outgoing data.

IMPORTANT: It is only possible to stop (block) outgoing data. It is not possible to stop (block) incoming data. If an application has created a bidirectional data stream, stopping the IP data stream, does not signal to the other endpoint to stop sending incoming data. Until the endpoint stops sending incoming data, the data will be transferred over the satellite link and billed.

NOTE: PPPoE connections are not affected by Manual Start/stop

DNS

The LT-4100 contains a recursive caching DNS server. The DNS server resolves names in the local domain (hostname and DHCP client names), and uses external DNS to resolve names in other domains.

It is possible to use external DNS servers directly (without using the caching DNS server). However, if the firewall is enabled it is recommended always to use the caching DNS server.

NOTE: If the firewall is enabled the DNS server only resolves names allowed by the firewall rules

NOTE: The DHCP server automatically announces the address of the DNS server. When the LT-4100 is in DHCP client mode or IP static mode, the PC must manually be configured to use the DNS server at the LT-4100

Outgoing firewall

The LT-4100 system allows the user to configure the outgoing firewall to only allow specific network traffic. This permits the user to block outgoing network traffic so that IP data is only used for warranted actions. The effect of this action is shown on Figure 51. Setting up the outgoing firewall is described in *Configuration, Network* on page 91.

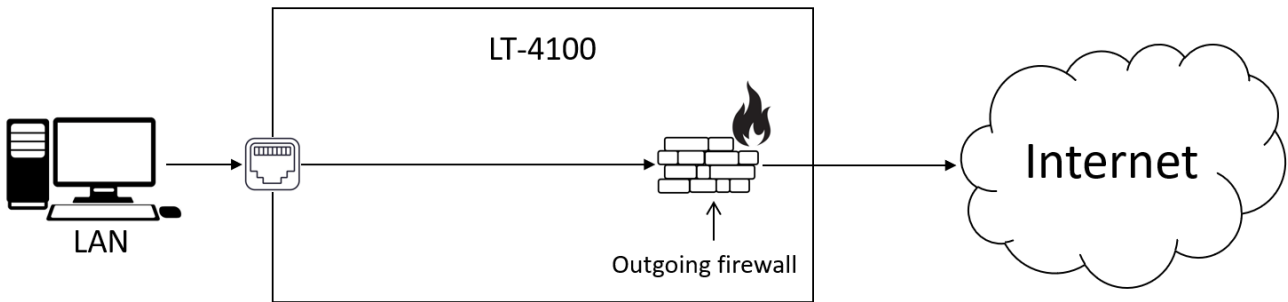

Figure 51: Outgoing firewall

Port forwarding

Port forwarding may be used on the LT-4100 system to remotely access IP data services running on user equipment connected to the LT-4100 LAN port. This allows the user of the system to configure web access for specific services using the LAN port on the LT-4100. To be able to use port forwarding, the IP address of the system using the LT-4100 LAN port should be statically assigned. This is explained in detail in *Web server, Network* on page 91.

NOTE: Port forwarding rules are not affected by using Manual Start/Stop for IP Data activation as that action only covers outgoing data.

Masquerading

If the user of the LT-4100 system has configured a data connection to a pc or service which has a preferred way of access to the Internet, then masquerading may be of use. Masquerading allows the user to change the IP address for services targeted by port forwarding or the DMZ host. The source IP address will be changed to the IP address of the LT-4100 LAN port. This forces the service to use the LT-4100 data service. An example of this is illustrated in Figure 52, where a DMZ host is used. With masquerading active the DMZ host can only see the LT-4100 LAN port IP address and is forced to use it to access the IP data.

Masquerading

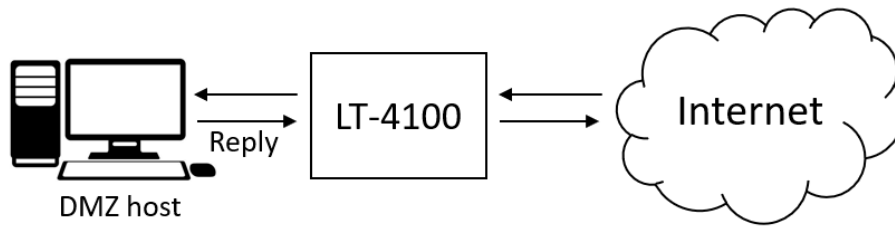

No masquerading

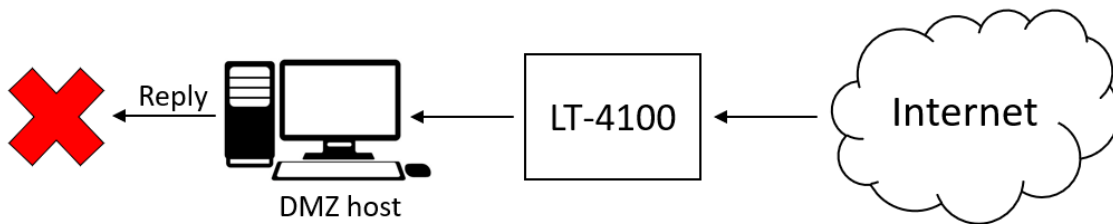

Figure 52: Port forwarding (masquerading)

Remote access

The LT-4100 system offers the user the ability to remotely access the LT-4100 web interface. This feature makes it possible to access the system from the internet. To enable activation of remote management it is required that the IP address provisioned to the terminal is known, and it is required that the IP address of the access point is provided to the Certus Service Provider. This is further described in *Public IP address* on page 58. How to configure the system for remote access is described in *System Submenus, Settings*.

NOTE: Remote access is not free of charge and costs data. Note that the remote access feature is not optimized.

Public IP address

To be able to use the remote access feature, the operator of the system needs to have the public IP address provisioned to the terminal, which is based on the IMEI and ICCID numbers. This is provisioned by Iridium, but the user must contact their Certus Service Provider for retrieval of the IP address.

In addition, the operator of the system needs to provide Iridium with the IP address of their remote access point. This IP address must also be provided to the Certus Service Provider. This is necessary as Iridium must configure their firewall to accept the IP address of the service point so that it can access the LT-4100 system remotely.

PPPoE

Point-to-Point Protocol over Ethernet (PPPoE) is a link layer network protocol used to facilitate direct communication between two network points. When PPPoE is used in an existing Ethernet/IP network, the PPPoE protocol creates an additional isolated IP network in parallel to the existing Ethernet/IP network. This logical separation of the two IP networks allows the LT-4100 to offer different properties and services on each network and thus also to the clients connected to the respective network. Something similar can be achieved with VLAN, but PPPoE has the additional advantages of being connection oriented and having built-in authentication.

Also important is that operating systems like Microsoft Windows can be easily configured **not** to send any data over the PPPoE network, except to/from applications explicitly configured to use the PPPoE network. Because PPPoE is connection oriented, the user can manually Connect/Disconnect from the PPPoE network and thus control data usage directly from the PC. Some applications can even Connect/Disconnect automatically making the use of PPPoE completely transparent. PPPoE is configured using the LT-4100 Web server, see the PPPoE section under *Network* on page 91.

NOTE: The IP data manual start/stop does **not** affect the PPPoE connection(s). To stop data flowing on a PPPoE connection, the PPPoE connection must be disconnected.

When configuring PPPoE in the LT-4100, it is optional whether the network traffic shall be routed through the firewall. Avoiding the firewall can be useful in case of trusted applications (e.g., weather or email) or for complete network devices trusted not to misuse the satellite link. The latter can be e.g IoT devices or an advanced network router, which can automatically route traffic between the LT-4100 and e.g., a VSAT system, depending on the availability of the VSAT service.

IMPORTANT: Do not configure the PC to use the PPPoE interface as the default route and simultaneously disable use of firewall

NOTE: The LT-4100 PPPoE uses CHAP for authentication. The Authentication phase is encrypted, but not for the IP data.

NOTE: PPPoE is per default disabled and must be activated for use.

NOTE: Instructions on PPPoE setup can be found in LT Tech Note 99-103028

Bluetooth

The LT-4100 system offers the user the ability to wirelessly connect equipment to the system using the Bluetooth interface. The Bluetooth feature enables the operator of the system to use the LT-4100 system data connection on their Bluetooth connected equipment. The system currently offers the ability to connect 8 devices simultaneously. The user should consider that connecting 8 devices and accessing data features on all 8 will result in slower data speeds as this divides the LT-4100 download between many devices. Because of this it is advised that the user only connects the needed number of devices.

Note the Bluetooth feature governs the set rules for the Outgoing Firewall regarding data transmission. For more information see Outgoing Firewall under *Data* on page 54.

NOTE: The built-in Bluetooth module and functionality will not be available in future production of the LT-4110 Control Unit due to manufacturer shortage and component obsolescence. In the display / GUI (MENU -> Settings -> Bluetooth) it can be verified if the Bluetooth module is mounted or not (the Bluetooth submenu will only be shown if the module is mounted).

PAN profile

The Bluetooth connectivity uses a wireless personal area network (WPAN) for connection. This provides data transmission from the LT-4110 Control Unit to Bluetooth connected devices. The connectivity is set up using the PAN profile which makes the Bluetooth network emulate an ethernet connection to connected devices. Applications running on connected devices will see the connection as through ethernet due to this simulation. The PAN profile is currently the only supported Bluetooth profile for the LT-4100 system. Therefore, Bluetooth functionality is limited to offering a data transmission between the connected device and the LT-4100 system.

How to pair

Pairing devices to the LT-4100 using Bluetooth is a straightforward operation. The user must enable Bluetooth on both the LT-4110 Control Unit and the device to pair. Bluetooth is enabled on the LT-4110 Control Unit in the Bluetooth submenu under the Settings menu, this is described in *System Submenus, Settings* on page 66. Figure 53 below shows the Bluetooth submenu with Bluetooth enabled, the system is now ready to pair.

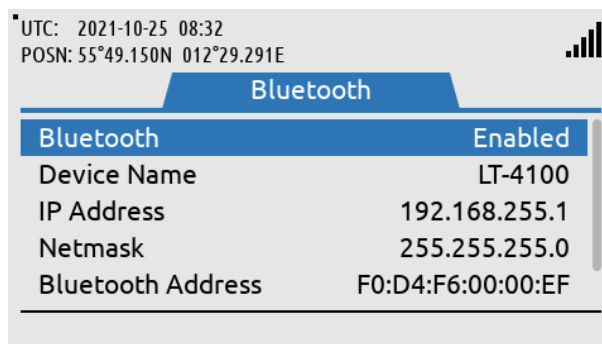

System:
MENU -> Settings-
>Bluetooth

Figure 53: Bluetooth (How to pair) 1/5

NOTE: For the LT-4100 to be able to pair to a Bluetooth device, the LT-4110 Control Unit must be in the Bluetooth submenu.

The LT-4100 is chosen from the Bluetooth list on the device which shall be connected. From there a pairing code will be displayed on the LT-4110 Control Unit screen, see Figure 54.

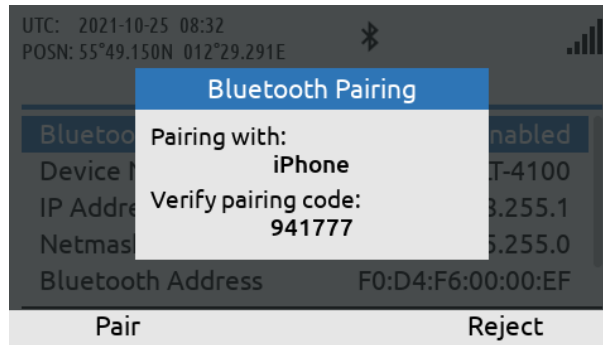

Bluetooth pairing request, press 'Pair' to pair

Figure 54: Bluetooth (How to pair) 2/5

The user can now either press 'Pair' to pair with the device or 'Reject' to reject pairing with the device. The 'Pair' softkey is pressed and the device (in this case an iPhone) is connected. The LT-4110 will now display the Bluetooth symbol as displayed on Figure 55.

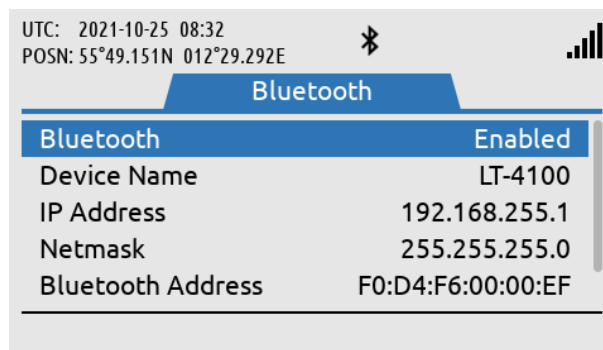

Bluetooth is enabled and a device is connected

Figure 55: Bluetooth (How to pair) 3/5

The connected device (in this case the iPhone) will now be displayed under 'Known Devices' at the bottom of the Bluetooth submenu, this is displayed on Figure 56.

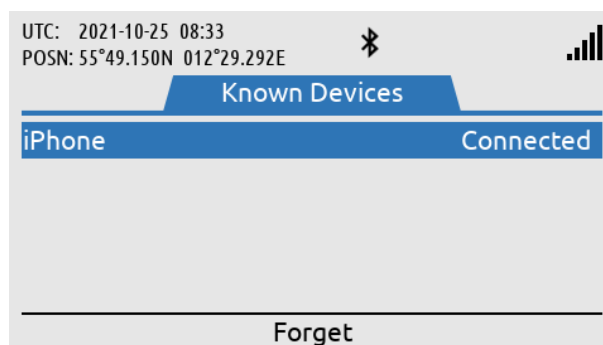

The connected device is shown under 'Known Devices'. Press 'Forget' to remove the device

Figure 56: Bluetooth (How to pair) 4/5

To disconnect the device from the LT-4100 the user can either disable Bluetooth on the LT-4110 Control Unit or the paired device or press the 'Forget' softkey. Using the 'Forget' softkey will remove the device from the list as seen on Figure 57.

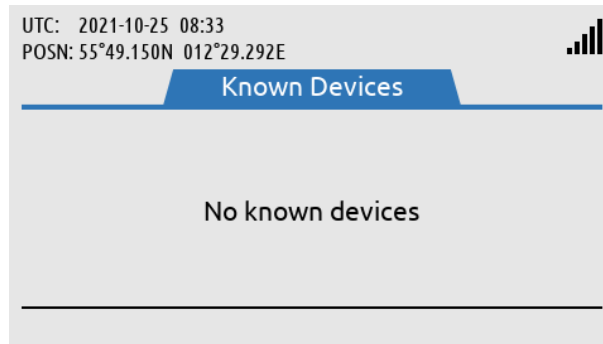

The device has been disconnected and forgotten

Figure 57: Bluetooth (How to pair) 5/5

System Submenus

This section describes and illustrates the submenus Phone, Settings, and System. The submenus are accessed by pressing the MENU button.

Phone

The Phone submenu contains the following entries: Contacts, Call History and Phone Usage, see Figure 58 for the layout of the Phone submenu.

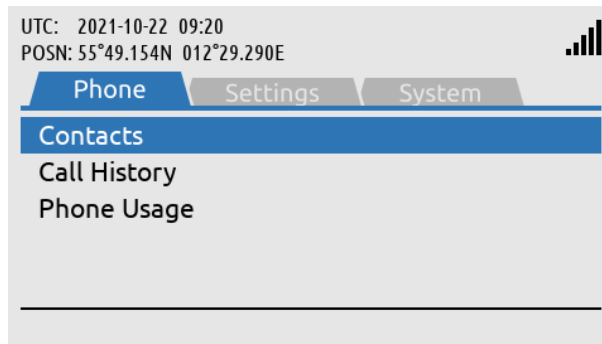

SIP Phones:
MENU -> Phone

Figure 58: Phone submenu

Contacts

The Contacts provides a list of contacts created by the user. Create a new contact by pressing the soft key 'New' and add phone number and name. The phone number is limited to numbers (e.g. 004529401008). It is currently not possible to add E-mail addresses under contacts. The Contact list can contain 100 contacts. Use international number prefix, either '+' or '00XX' in front of the number. A contact can be deleted from the list by pressing the soft key 'Delete' and confirm this.

NOTE: The user can select an entry from the Contacts (e.g. Test Phone) and use the Off-hook button to establish a voice call to the contact.

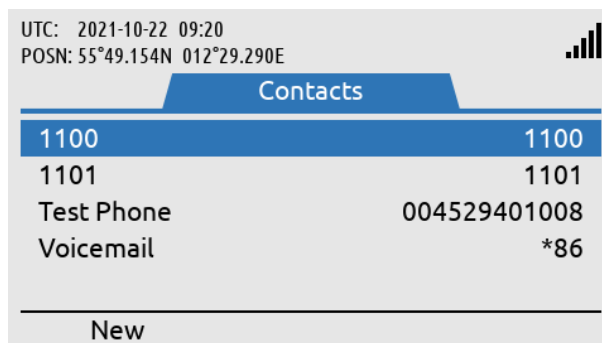

Contacts:
MENU -> Phone ->
Contacts

Figure 59: Phone submenu (Contacts)

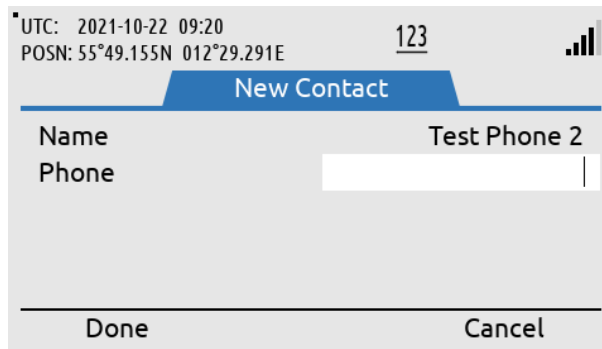

Adding a new contact:
Input name and phone
number

Figure 60: Contacts (New Contact)

Call History

The Call History provides a complete list of all voice calls: outgoing, incoming, and missed calls, as illustrated in Figure 61. ‘Unknown’ entries in the Call History will show the soft key ‘New Contact’ to help creating the ‘Unknown’ contacts in the Contact list. Use the soft key ‘Show Missed’ to filter for incoming missed calls.

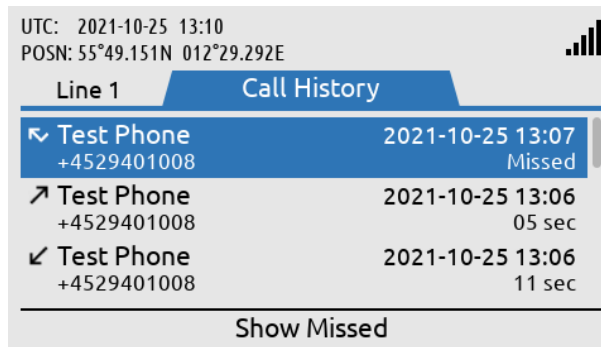

Call History:
MENU -> Phone -> Call
History

Figure 61: Phone submenu (Call History)

Phone Usage

The Phone Usage lists Trip and Lifetime user terminal usage. The list includes voice totals for ingoing and outgoing voice calls for both voice lines. Besides voice the list also includes data download, upload and total usage. To switch between Trip and Lifetime usage, press the softkey titled ‘Show Lifetime/Trip’. The list is illustrated in Figure 62 to Figure 65.

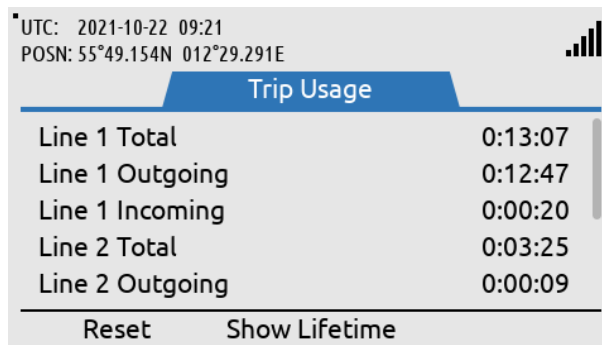

Phone Usage:
MENU -> Phone -> Phone
Usage
(Trip usage, upper view)

Figure 62: Phone submenu (Phone Usage)

UTC: 2021-10-22 09:21
 POSN: 55°49.154N 012°29.291E

Trip Usage	
Line 2 Outgoing	0:00:09
Line 2 Incoming	0:03:16
Data Total	2.324 MB
Data Download	2.178 MB
Data Upload	145.321 kB

Reset Show Lifetime

Phone Usage:
 MENU -> Phone -> Phone Usage
 (Trip usage, lower view)

Figure 63: Phone submenu (Phone Usage)

UTC: 2021-10-22 09:21
 POSN: 55°49.154N 012°29.291E

Lifetime Usage	
Line 1 Total	0:13:07
Line 1 Outgoing	0:12:47
Line 1 Incoming	0:00:20
Line 2 Total	0:03:25
Line 2 Outgoing	0:00:09

Show Trip

Phone Usage:
 MENU -> Phone -> Phone Usage
 (Lifetime usage, upper view)

Figure 64: Phone submenu (Phone Usage)

UTC: 2021-10-22 09:21
 POSN: 55°49.154N 012°29.291E

Lifetime Usage	
Line 2 Outgoing	0:00:09
Line 2 Incoming	0:03:16
Data Total	2.324 MB
Data Download	2.178 MB
Data Upload	145.321 kB

Show Trip

Phone Usage:
 MENU -> Phone -> Phone Usage
 (Lifetime usage, lower view)

Figure 65: Phone submenu (Data Usage)

NOTE: The Data Total, Data Download and Data Upload are not 100% precise as the system e.g., in the case of a failed Data Upload will retry sending the information. Therefore, the numbers in the Phone Usage menu as seen on Figure 65, will not be 100% accurate.

Settings

The Settings submenu contains the following entries: Audio, Display, Date & Time, Phone Setup, Bluetooth, Security and Reset Options. See Figure 66 and Figure 67 for the layout of the Settings submenu.

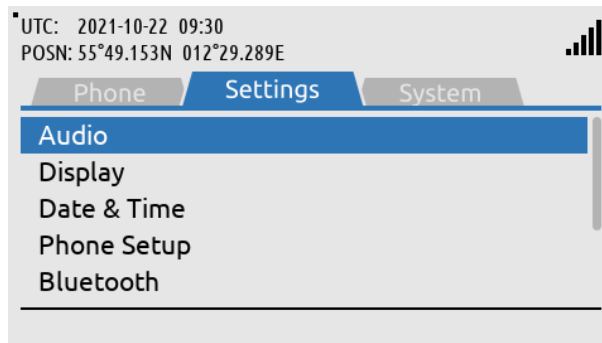

Settings:
MENU -> Settings
(upper view)

Figure 66: Settings submenu

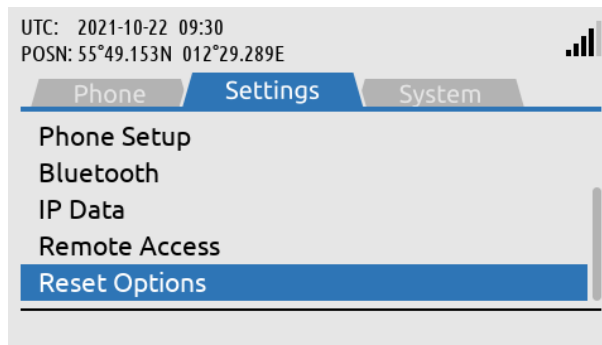

Settings:
MENU -> Settings
(lower view)

Figure 67: Settings submenu

Audio

The Audio settings handles all audio levels and notifications. Here is a short description of the audio settings and their functionality in the LT-4100 system (see Figure 68 for layout):

- *Speaker Volume* adjusts the output level of the LT-4110 Control Unit speaker (located below the Brightness button). The Speaker Volume setting is primarily used when operating the system with the LT-3120 Handset placed in LT-3121 Cradle (e.g. making a voice call). The Navigation key (arrows up/down) can be used to control the Speaker Volume output level, when audio is directed to control unit speaker.
- *Handset Volume* adjusts the output level of the LT-3120 Handset speaker (user audio). The user can adjust the Handset Volume during a voice call by using the LT-3120 Handset volume button (up/down) on the side of the handset.
- *Ringer Volume* adjusts the output level of the ringer when an incoming voice call is presented in the LT-4100 system. The Ringer output will be directed to the LT-3120 Handset (integrated ringer speaker on the back side) when placed in the LT-3121 Cradle. Otherwise, the LT-4110 Control Unit speaker is used for indicating an incoming voice call.
- *Key Beep* adjusts the output level of the audio feedback when using the LT-4110 Control Unit keypad. Can be configured to 'Off' if desired.

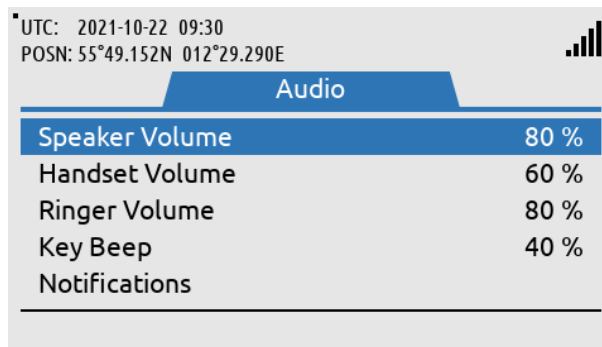

Audio:
MENU -> Settings ->
Audio

Figure 68: Settings submenu (Audio)

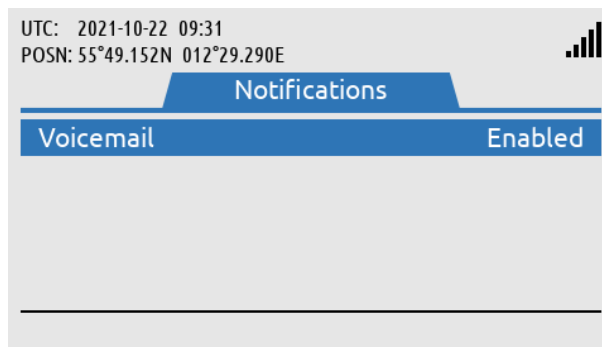

Notifications:
MENU -> Settings ->
Audio -> Notifications

Figure 69: Settings Submenu (Notifications)

Display

The Display settings handles all display settings: mode (day or night time) and brightness.

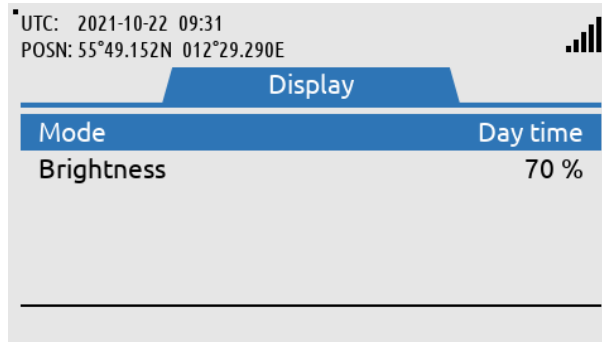

Display:
MENU -> Settings ->
Display

Figure 70: Settings submenu (Display)

NOTE: The display settings can also be configured using the ‘Brightness’ button. Short press on the ‘Brightness’ button changes the brightness, whereas long press on the ‘Brightness’ button changes between day and nighttime.

Date & Time

Date & Time settings provides the user with a possibility to change formats after completing the Installation Wizard. The LT-4100 system supports the following date formats: YYYY-MM-DD, D MMM YYYY, DD/MM/YYYY, and MM/DD/YYYY. The time format can be configured to either 24 or 12 hours.

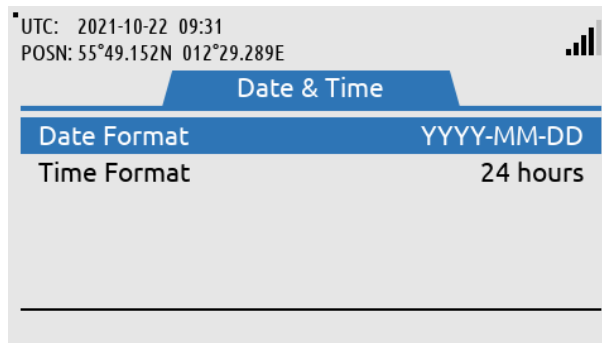

Date & Time:
MENU -> Settings -> Date
& Time

Figure 71: Settings submenu (Date & Time)

Phone Setup

As described in *System Services, Voice Call* on page 49, the LT-4100 system offers two voice lines. In the phone setup submenu, the user can choose to either automatically choose line or to manually choose line. If manual is selected, the user will have to choose between Voice line 1 and line 2 each time an outgoing call is established from the LT-4110 Control Unit. The selection of Automatic or Manual can be seen on Figure 72 and Figure 73.

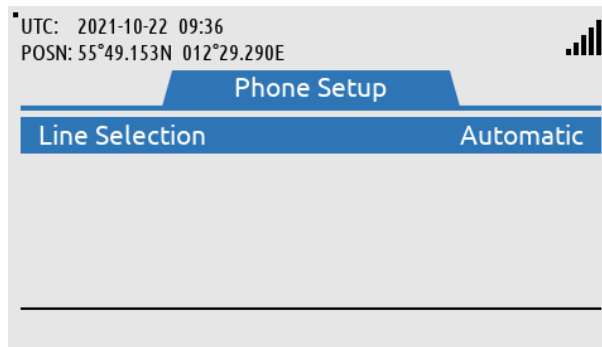

Phone Setup:
MENU -> Settings ->
Phone Setup

Figure 72: Settings submenu (Phone Setup)

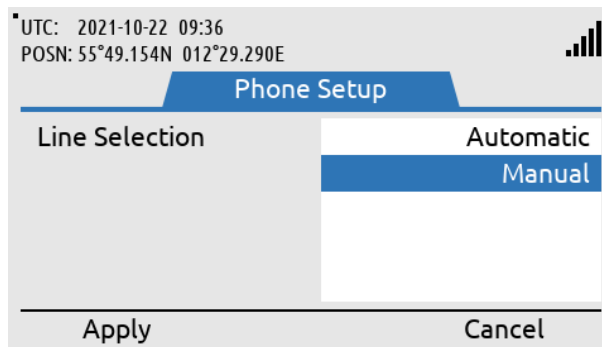

Choose between
'Automatic' or 'Manual'
voice line selection for
outbound calls from the
LT-4110

Figure 73: Settings submenu (Phone Setup)

Bluetooth

The Bluetooth submenu offers the user the ability to wirelessly connect devices to the LT-4100 using Bluetooth. How to setup this connection is described in *Bluetooth, How to pair* on page 60.

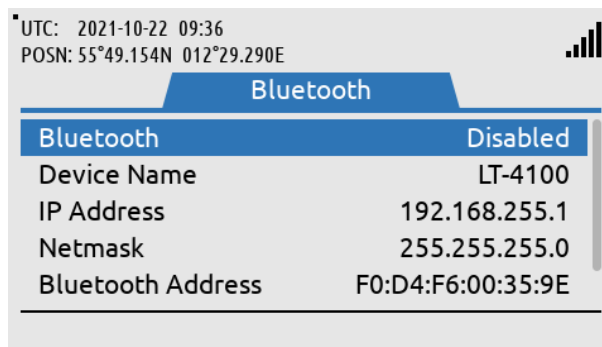

Phone Setup:
MENU -> Settings ->
Bluetooth

Figure 74: Settings submenu (Bluetooth)

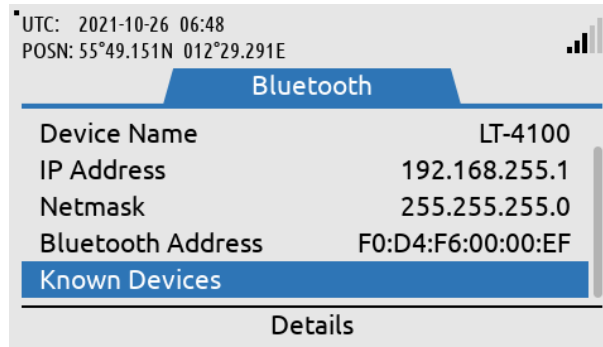
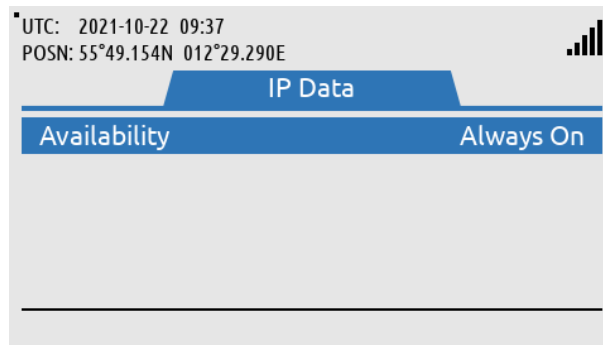

Figure 75: Settings submenu (Bluetooth)

IP Data

As described in *Data, Data* on page 54, the user has the ability either manage outgoing data usage as either 'Always On' or 'Manual' selection. The selection between the two is performed on the LT-4110 Control unit and can be seen on Figure 76 and Figure 77.



Phone Setup:
MENU -> Settings -> IP
Data

Figure 76: Settings submenu (IP Data)

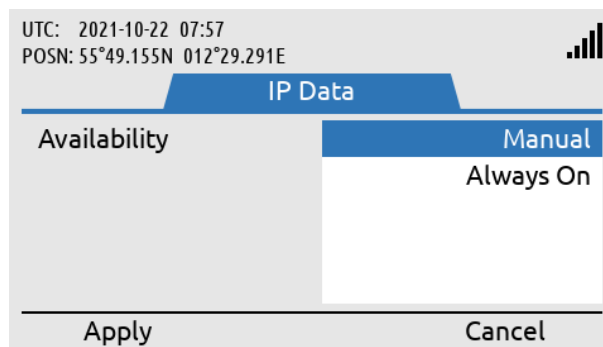

Choose between
'Manual' or 'Always On'
for outbound IP Data

Figure 77: Settings submenu (IP Data)

Remote access

The remote access submenu allows configuration of the LT-4100 system, enabling remote access to the LT-4100 web interface. To allow remote access to the LT-4100 web interface the prerequisites for IP addresses must be met, and remote access must be enabled as shown on Figure 78 to Figure 80.

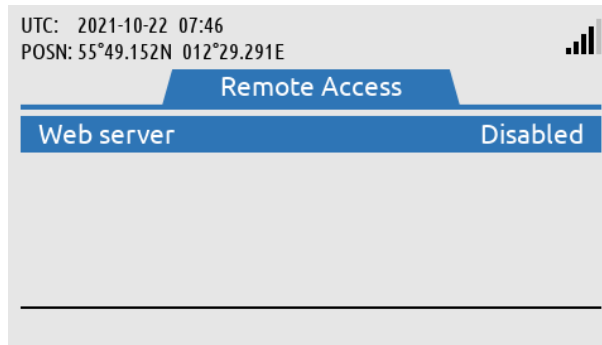

Phone Setup:
MENU -> Settings ->
Remote Access

Figure 78: Settings submenu (Remote Access)

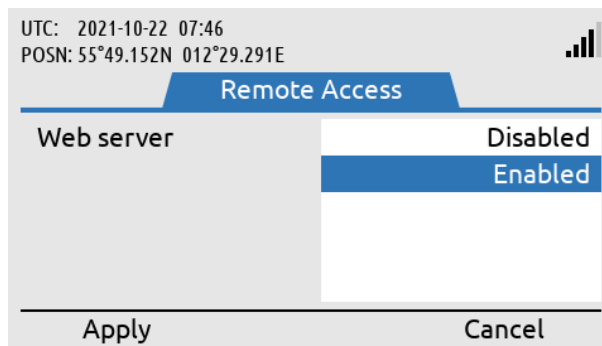

The user must enable remote access on the Control Unit

Figure 79: Settings submenu (Remote Access)

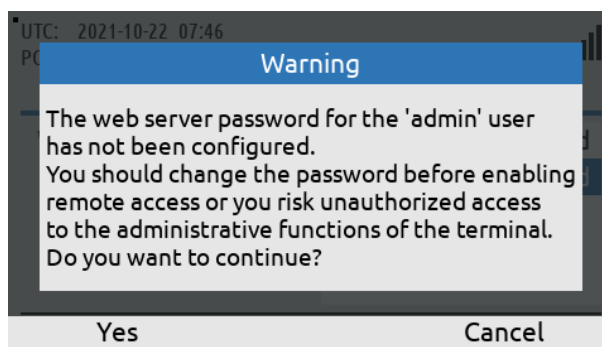

If the default admin user password for the web server is used, the system will ask for a password change. Press 'Yes' to continue

Figure 80: Settings submenu (Remote Access)

Reset Options

The Reset Options submenu handles the reset of the following user records and configurations: Call History, Web Server Authentication and Resetting network settings using by entering Network Recovery Mode. Use the soft key 'Execute' or the 'ENTER' button to activate the reset, when the correct Reset Option has been selected by the 'Navigation' key (arrow up/down). The user of the LT-4100 system will have to confirm the reset, see Figure 81 and Figure 82.

The Clear History function allows the user to reset all call and data history to default. When executing a reset command, the system will prompt a pop-up to ensure that the action is confirmed.

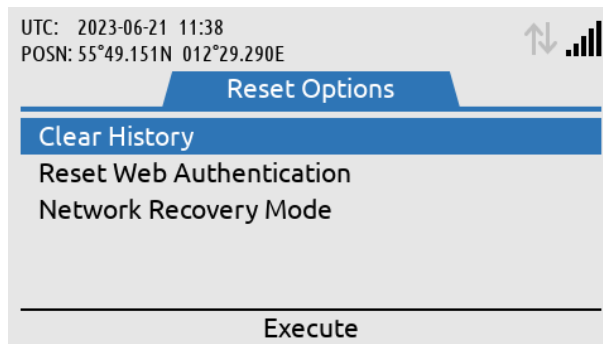

Phone Setup:
MENU -> Settings ->
Reset Options

Figure 81: Settings submenu (Reset Options)

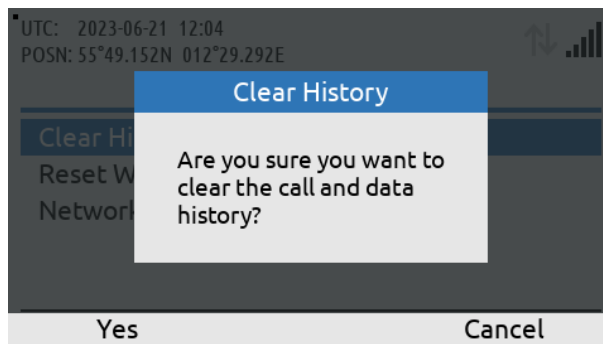

The user must confirm the reset to clear the selected data from memory

Figure 82: Settings submenu (Reset Options)

The Reset Web Authentication command allows the user to reset as implied the authentication for the LT-4110 Web Server. This resets the username and password to default values (admin/admin). See Figure 83 below.

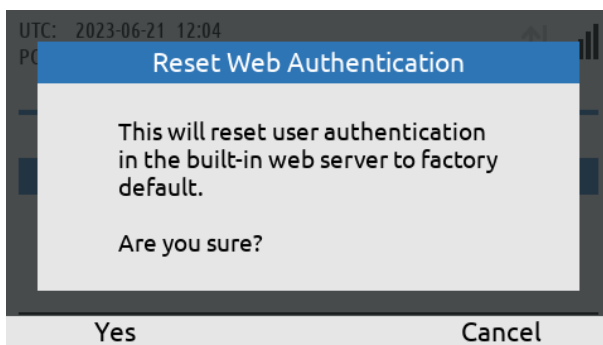

Figure 83: Settings submenu (Reset Options)

NOTE: The reset of the web server authentication can be managed from the Settings submenu for the user to get access to the web server in the situation where the user cannot find the changed password. To avoid unwanted access to the web server via the network interface, it is highly recommended to change the web server authentication password at any time. The web server authentication is described and illustrated in *Authentication* on page 90.

Network Recovery mode can be used if the user of the system has wrongly configured the Network settings and is locked out of the web server, see Figure 84 below.



Figure 84: Settings submenu (Reset Options)

Once Network Recovery Mode is activated, this will be displayed on the Web Server. The Web Server Network settings will revert to factory default values. When entering the Web Server the user will be able to reconfigure these settings. The settings will be displayed on the Web Server as they were prior to entering Network Recovery Mode. See Figure 85 below.

LT-4100 System Dashboard Configuration Maintenance Legal notice Log out Disable login timeout	UTC: 21 Jun 2023 11:42:14 POSN: 55°49.152N 12°29.292E																																																																		
Warning Network recovery mode. Change network configuration and reboot the system.																																																																			
<table border="0" style="width: 100%;"> <tr> <th colspan="2" style="text-align: left;">System Information</th> <th colspan="2" style="text-align: left;">System Units</th> </tr> <tr> <td style="width: 50%;">System Number</td> <td style="width: 25%;">LT-4100</td> <td style="width: 12.5%;">Number</td> <td style="width: 12.5%;">Name</td> </tr> <tr> <td>Software Version</td> <td>v1.04R-0002</td> <td>LT-4110</td> <td>Control Unit</td> </tr> <tr> <td>IMEI</td> <td>300058060003160</td> <td>LT-4130</td> <td>Antenna Unit</td> </tr> <tr> <td>ICCID</td> <td>8988169771000134511</td> <td></td> <td>Connected</td> </tr> </table>		System Information		System Units		System Number	LT-4100	Number	Name	Software Version	v1.04R-0002	LT-4110	Control Unit	IMEI	300058060003160	LT-4130	Antenna Unit	ICCID	8988169771000134511		Connected																																														
System Information		System Units																																																																	
System Number	LT-4100	Number	Name																																																																
Software Version	v1.04R-0002	LT-4110	Control Unit																																																																
IMEI	300058060003160	LT-4130	Antenna Unit																																																																
ICCID	8988169771000134511		Connected																																																																
<table border="0" style="width: 100%;"> <tr> <th colspan="4" style="text-align: left;">Telephony</th> <th colspan="4" style="text-align: left;">Data</th> </tr> <tr> <td colspan="4" style="text-align: left;">Outgoing Lines</td> <td colspan="4" style="text-align: left;">Satellite Data Services</td> </tr> <tr> <td style="width: 5%;">Line</td> <td style="width: 15%;">Type</td> <td style="width: 20%;">Number</td> <td style="width: 20%;">Status</td> <td style="width: 10%;">Name</td> <td style="width: 10%;">Status</td> <td style="width: 10%;">Rx</td> <td style="width: 10%;">Tx</td> </tr> <tr> <td>1</td> <td>Postpaid</td> <td>+881677114525</td> <td>Idle</td> <td>Background IP</td> <td>Up</td> <td>113.896 MB</td> <td>62.578 MB</td> </tr> <tr> <td>2</td> <td>Postpaid</td> <td>+881677122061</td> <td>Idle</td> <td colspan="4" style="text-align: left;">Local Interfaces</td> </tr> <tr> <td colspan="4" style="text-align: left;">Phones</td> <td style="text-align: left;">Interface</td> <td style="text-align: left;">Protocol</td> <td style="text-align: left;">Service</td> <td style="text-align: left;">Firewall</td> <td style="text-align: left;">Status</td> </tr> <tr> <td>1000</td> <td>LT-4100 User</td> <td></td> <td>Idle</td> <td>LAN</td> <td>IP</td> <td>Background IP</td> <td>Enabled</td> <td>Started</td> </tr> <tr> <td>1104</td> <td>KPI Test</td> <td></td> <td>Unregistered</td> <td colspan="4"></td> </tr> </table>		Telephony				Data				Outgoing Lines				Satellite Data Services				Line	Type	Number	Status	Name	Status	Rx	Tx	1	Postpaid	+881677114525	Idle	Background IP	Up	113.896 MB	62.578 MB	2	Postpaid	+881677122061	Idle	Local Interfaces				Phones				Interface	Protocol	Service	Firewall	Status	1000	LT-4100 User		Idle	LAN	IP	Background IP	Enabled	Started	1104	KPI Test		Unregistered				
Telephony				Data																																																															
Outgoing Lines				Satellite Data Services																																																															
Line	Type	Number	Status	Name	Status	Rx	Tx																																																												
1	Postpaid	+881677114525	Idle	Background IP	Up	113.896 MB	62.578 MB																																																												
2	Postpaid	+881677122061	Idle	Local Interfaces																																																															
Phones				Interface	Protocol	Service	Firewall	Status																																																											
1000	LT-4100 User		Idle	LAN	IP	Background IP	Enabled	Started																																																											
1104	KPI Test		Unregistered																																																																
<table border="0" style="width: 100%;"> <tr> <th style="text-align: left;">BAM</th> </tr> <tr> <td>No active alerts</td> </tr> </table>		BAM	No active alerts																																																																
BAM																																																																			
No active alerts																																																																			

Figure 85: Settings submenu (Reset Options – Network Recovery Mode)

System

The System submenu contains the following entries: BAM Alert, Network, SIP Phones, GNSS Status, Subscription, System Info, and Power Supply. See Figure 86 and Figure 87 for the layout of the System submenu.

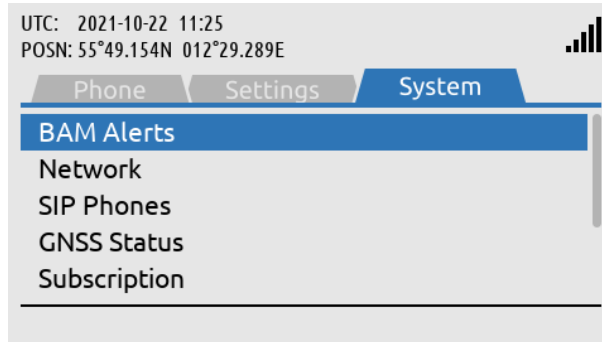

System:
MENU -> System
(upper view)

Figure 86: System submenu

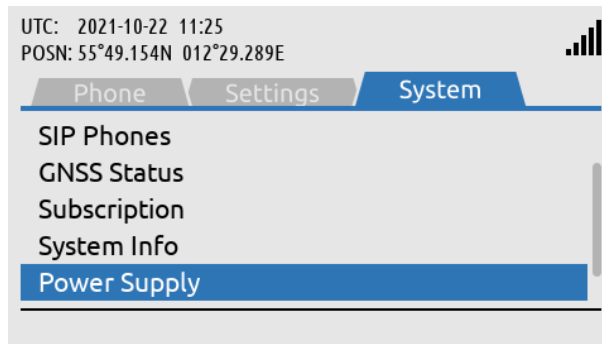

System:
MENU -> System
(lower view)

Figure 87: System submenu

BAM Alerts

BAM Alerts provides an overview of the active alerts in the LT-4100 system. The Bridge Alert Management (BAM) is described and illustrated in detail in *Bridge Alert Management (BAM)* on page 79.

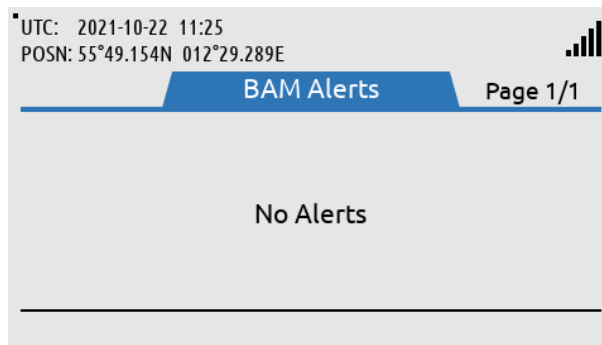

BAM Alerts:
MENU -> System -> BAM
Alerts (or long press on
the MENU button)

Figure 88: System submenu (BAM Alerts)

NOTE: The BAM Alerts list illustrated in Figure 88 should under normal conditions be empty (No Alerts). Make sure to read the alerts carefully and take appropriate action.

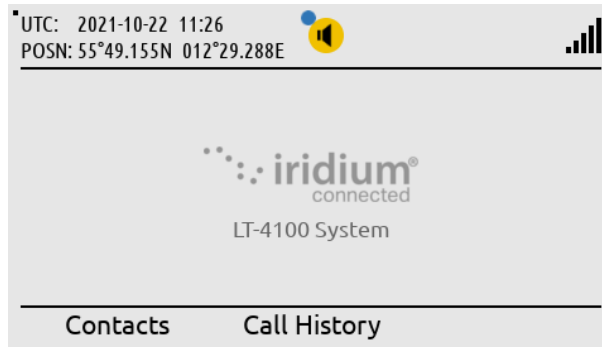

BAM alert shown in the status bar (active warning). The blue dot indicates a change in the BAM Alerts, after the user has last been in the list.

Figure 89: BAM Alerts (1 of 4)

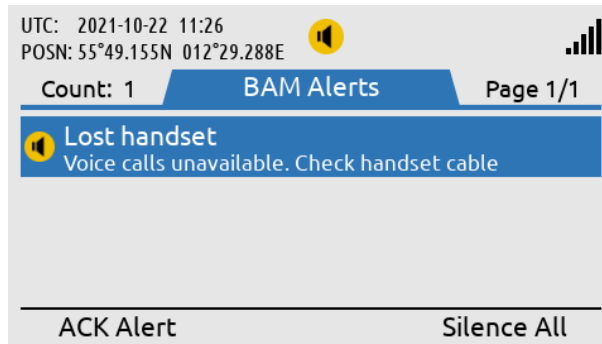

Long press on the MENU button to access the BAM Alerts (Lost Handset).

Figure 90: BAM Alerts (2 of 4)



Press the soft key 'Silence All' to mute the audible alarm for 30 seconds.

Figure 91: BAM Alerts (3 of 4)

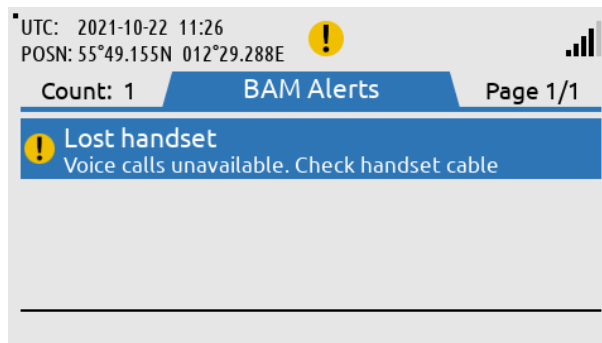

Press the soft key 'ACK Alert' acknowledge the BAM alert.

Figure 92: BAM Alerts (4 of 4)

Network

The Network provides an overview for the user of the LT-4100 system of the IP network configuration and setup. The LT-4100 system can be configured to: DHCP Client, DHCP Server, and Static IP address. The link status will provide the user with information about and whether an IP connection is established to the LT-4110 Control Unit. The IP address of the LT-4110 Control Unit is provided under the IP Address parameter illustrated in Figure 93.

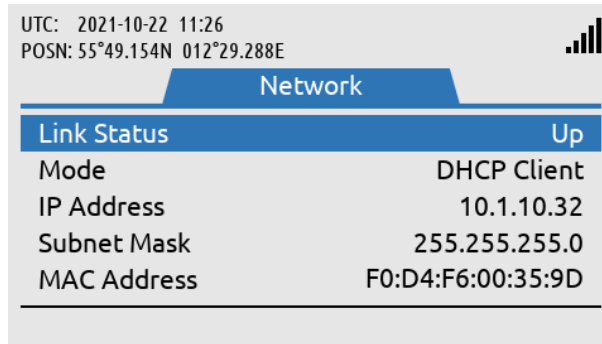

Network:
MENU -> System ->
Network

Figure 93: System submenu (Network)

NOTE: Use the IP Address to access the built-in web server. Instructions to access the built-in web server is provided in *Accessing the built-in web server* on page 87.

SIP Phones

The SIP Phones functionality is described and illustrated in *External SIP Phones* on page 50.

GNSS Status

The GNSS Status provides an overview for the user of the LT-4100 system built-in GNSS receiver. The GNSS receiver can be configured from the web server, see *GNSS and BAM* on page 110.

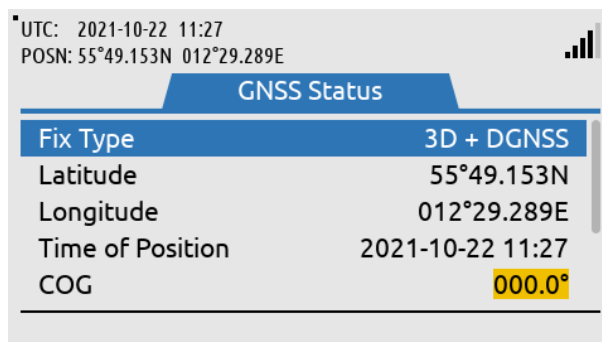

GNSS Status:
MENU -> System -> GNSS
Status
(upper view)

Figure 94: System submenu (Position Status)

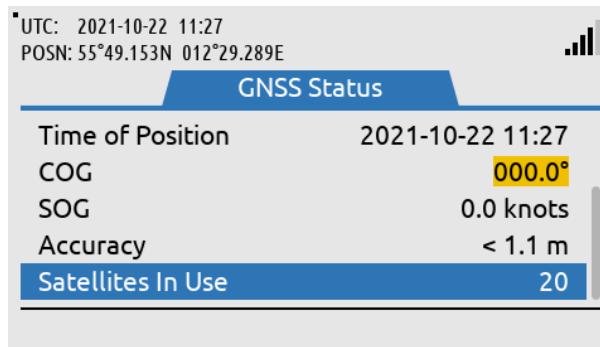

GNSS Status:
MENU -> System -> GNSS
Status
(lower view)

Figure 95: System submenu (Position Status)

NOTE: The GNSS Status window shows the GNSS receiver status. The GNSS Status integrity states are further described and illustrated in *App. F GNSS Receiver Integrity States* on page 128.

Subscription

The subscription submenu provides the user with an overview of the subscribed services. This is shown on Figure 96. Voice Service has an additional sub-menu where the two Voice lines can be seen. There the MSISDN (satellite phone number) numbers, and subscription type can also be found. This is shown on Figure 97.

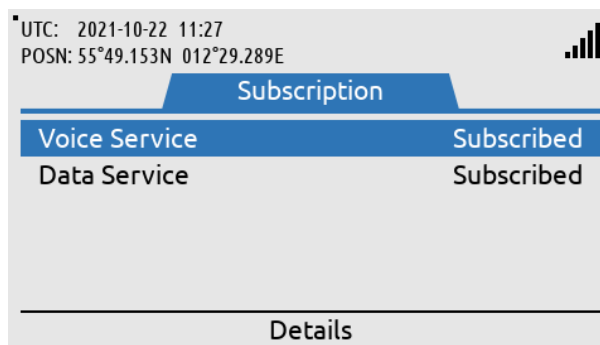

Subscription:
MENU -> System ->
Subscription

Figure 96: System submenu (Subscription)

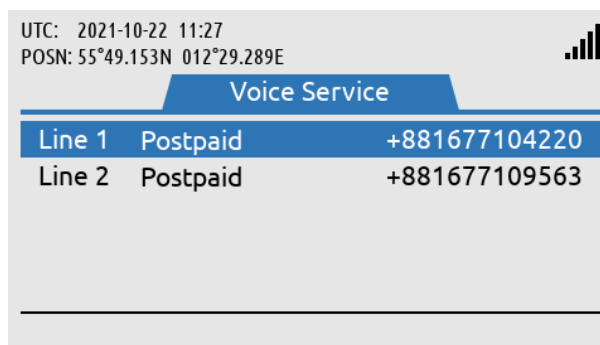

Voice Service submenu:
MSISDN number and
subscription type for each
voice line is listed

Figure 97: System submenu (Subscription)

System Info

The System Info submenu provides details about the LT-4100 system software and hardware. In addition, the following numbers are available: IMEI (~mobile equipment number) and ICCID (~SIM card number). The System Info is illustrated in Figure 98 and in Figure 99.

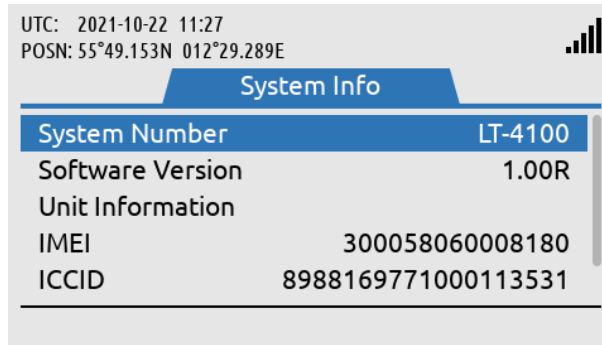

System Info:
MENU -> System -> System Info
(upper view)

Figure 98: System Submenu (System Info)

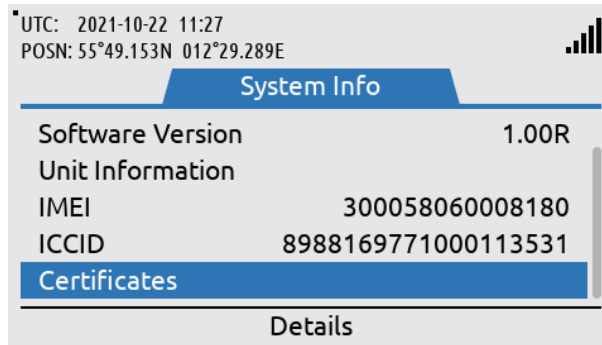

System Info:
MENU -> System -> System Info
(lower view)

Figure 99: System submenu (System Info)

Power Supply

The Power Supply submenu provides details about the DC input voltage on the LT-4110 Control Unit, LT-4130 Antenna Unit and the LT-4110 Control Unit output current. The submenu is shown on Figure 100.

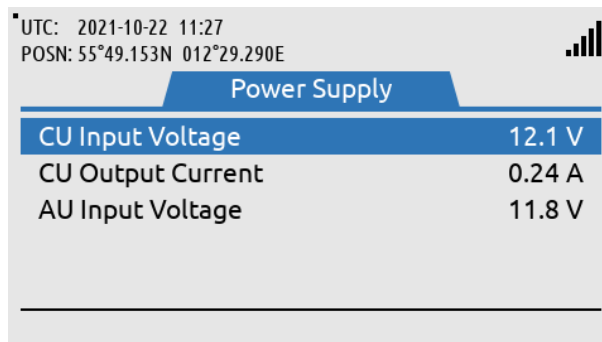

Figure 100: System submenu (Power Supply)

Bridge Alert Management (BAM)

Bridge Alert Management (BAM) is the IMO defined overall concept for the harmonized management, distribution, handling, and presentation of alerts on the bridge, to enable the bridge team to devote full attention to the safe operation of the ship and to immediately identify any alert situation requiring action to maintain the safe operation of the ship. The LT-4100 system implements the BAM concept in compliance with the relevant standards (IEC 62923-1 and IEC 62923-2 Bridge Alert Management).

BAM status

The LT-4100 system continuously monitors for fault conditions (e.g. no satellite signal), that requires the attention of the bridge team and raises relevant alerts. The user can, at any time, check for the presence of alerts without performing any action: if there are one or more active alerts, a BAM icon representing the alert with the highest priority is shown in the status bar (see Figure 101). The exact icon shown depends on the priority and state of the alert with the highest priority (see Table 21 on page 80). It is not possible to hide or suppress the BAM icon in the status bar.

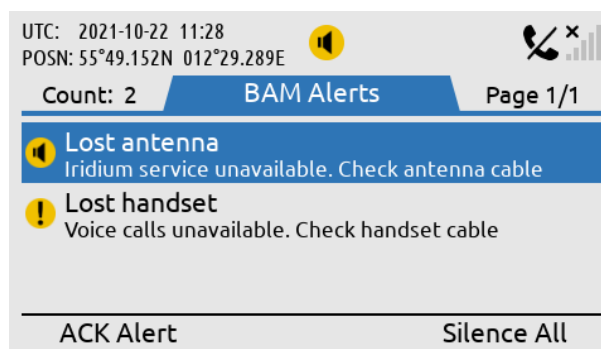

Figure 101: LT-4110 Control Unit (BAM status)

Alert list

Once the user has become aware an alert has been raised, the user can navigate to the alert list (MENU -> System -> BAM Alerts) to find further information about the alert conditions.

NOTE: For quick access to the alert list, long press (≥ 1 s) the MENU button at any time.



The BAM Alerts window will list the current unacknowledged and acknowledged alerts.

Figure 102: LT-4110 Control Unit (BAM Alert list)

See *App. B Bridge Alert Management (BAM)* on page 121 for the full list of alerts that can be raised by the LT-4100 system.

Alert priority and state

The *priority* of an alert indicates its severity. The BAM concept defines 4 priorities: Emergency Alarm, Alarm, Warning and Caution. The LT-4100 system can raise alerts of the following priorities:

- **Warning:** Condition requiring immediate attention, but no immediate action by the bridge team. Warnings are presented for precautionary reasons to make the bridge team aware of changed conditions which are not immediately hazardous but may become so if no action is taken.
- **Caution:** Lowest priority of an alert. Awareness of a condition which does not warrant an alarm or warning condition, but still requires attention out of the ordinary consideration of the situation or of given information.

The shape and color of the BAM icon indicates the priority of the alert and the symbol inside indicates its state as per Table 21 below.







BAM Alert Icons, Priority and Stat				
Priority	Icon	State	Condition	Audible signal
Warning		Active – unacknowledged	Alert condition present. Alert not acknowledged.	Yes
		Active – silenced	Alert condition present. Alert not acknowledged, but audible signal has been silenced by the operator.	No
		Active – acknowledged	Alert condition present. Alert acknowledged by the operator.	No
		Active – responsibility transferred	Alert condition present. A function of the BAM compliant equipment with additional system knowledge has taken over.	No
		Rectified – unacknowledged	Alert condition rectified. Alert still unacknowledged.	No
	None	Normal	No alert condition present.	No
Caution		Active	Alert condition present.	No
	None	Normal	No alert condition present.	No

Table 21: BAM Alert Icons, Priority and State

Temporary silence

Active unacknowledged alerts cause a short but periodically repeated audible signal. To temporarily silence all alerts (and thus the audible signal), press the “Silence All” soft key. The temporary silence period expires after 30 s, after which active silenced alerts become active unacknowledged alerts again, causing the audible signal to resume.

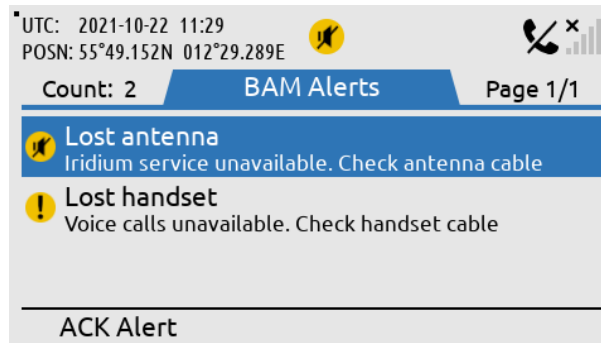

Figure 103: LT-4110 Control Unit (BAM Alerts)

NOTE: Active unacknowledged alerts cause a short but periodically repeated audible signal, which can be temporary silences (30 s) by pressing the soft key ‘Silence All’. This temporary silence has been illustrated in Figure 103.

Alert acknowledgement

Alerts of priority warning must be acknowledged by the user. To acknowledge an alert, press the “ACK Alert” soft key.

Some alerts cannot be acknowledged by the user, in which case the “ACK Alert” soft key will be absent. This applies to alerts for which the alert text and alert description is not enough for decision support.

When an alert is both acknowledged and rectified it disappears from the alert list. Cautions cannot be acknowledged and thus disappear as soon as they are rectified.

Aggregation

The BAM concept defines aggregation as a means for an alert source to combine multiple individual alerts of the same kind into a single aggregated header alert in order to help reduce the risk that the number of individual alerts obscures the display of equally important additional alerts, for example due to the active alert list length exceeding the maximum display capability of the alert source UI.

NOTE: The LT-4100 system currently does not define any alerts that can be aggregated.

Responsibility transfer

The BAM concept defines the Central Alert Management (CAM) system as equipment used for centralizing management, handling and presentation of alerts on the bridge. A CAM system may be standalone or combined with other equipment, for example in the case of an Integrated Navigation System (INS).

A CAM system connects to multiple alert sources (such as the LT-4100 system) in order to manage and present their alerts on the CAM UI. An alert will thus be presented in the alert list of both the alert source and the CAM system.

To reduce the number of high-priority audible alerts for one situation that requires attention, if the CAM system has additional knowledge regarding an alert situation, which caused the LT-4100 system to raise an alert, the CAM system may apply responsibility transfer and raising a new alert with, if practicable, a lower priority.

NOTE: Alerts of priority caution are not audible and therefore cannot have their responsibility transferred.

NOTE: The LT-4100 will reject the request for responsibility transfer if no HBT sentence (indicating good status) has been received from the CAM system within the last 90 s.

The alert text and alert description of an alert is presented on the CAM system. For some alerts, additional information must be presented in order to allow user acknowledgement of the alert. Responsibility transfer is not allowed for such alerts as they can only be acknowledged at the alert source, where the additional information is present.

Time synchronization

The LT-4100 system can supply the UTC time of alert state changes to the CAM system due to the built-in GNSS receiver.

NOTE: If the alert state change occurs before the built-in GNSS receiver has obtained the UTC time or in case of GNSS receiver malfunctioning, the LT-4100 system will not supply the UTC time.

Serial Interface (RS-422)

GNSS sentences

The LT-4100 system supports outputting of GNSS sentences encoded as NMEA 0183 via an RS-422 interface from the LT-4100 system, as illustrated in Figure 104. The LT-4100 system has a built-in GNSS receiver in the LT-4130 Antenna Unit.

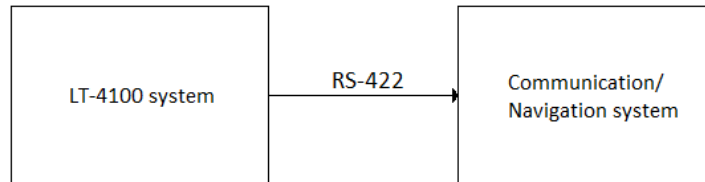

Figure 104: GNSS sentences

Table 22 presents the supported GNSS sentences by the LT-4100 system. The configuration of the GNSS sentences are illustrated and described in *GNSS and BAM* on page 110.

GNSS Sentences			
Sentence	Baud Rate		
	4.800	9.600	38.400
DTM	X	X	X
GGA	X	X	X
GLL	X	X	X
GSA	X	X	X
GSV	-	X	X
RMC	X	X	X
VTG	X	X	X
ZDA	X	X	X

Table 22: GNSS sentences

IMPORTANT: The GNSS receiver of the LT-4100 system is not certified according to IMO performance standards for GNSS receivers. The LT-4100 system shall not be connected to equipment where the GNSS receiver interface must be certified.

The GNSS sentences and decoding of these are further documented in *App. D GNSS sentences* on page 126.

BAM sentences

The LT-4100 system supports connection to an external Central Alert Management (CAM) system via an RS-422 interface from the LT-4100 system, as illustrated in Figure 105. The CAM system can receive BAM information (e.g. warning and cautions) from the bridge equipment and centralize and present this information to the user, which can be acknowledged to the BAM equipment (here the LT-4100 system).

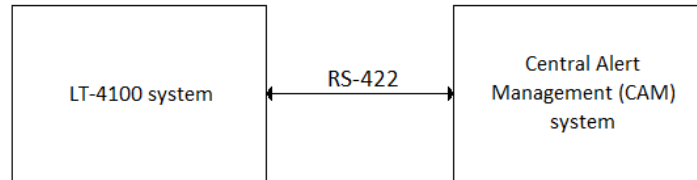

Figure 105: CAM/BAM system

Table 23 presents the supported BAM sentences by the LT-4100 system. The configuration of the BAM sentences is illustrated and described in *GNSS and BAM* on page 110.

Sentences Received by SES		
Sentence	Name	Comment
ACN	Alert Command	Alert command for instance acknowledge
HBT	Heartbeat	Support reliable alert related communication
Sentences Transmitted by SES		
Sentence	Name	Comment
ARC, ALC, ALF	Alert information	

Table 23: BAM sentences

NOTE: The encoding of BAM sentences is defined in IEC 61162-1 (Edition 5.0, 2016-08), the encoding is similar to NMEA 0183.

The BAM sentences and decoding of these are further documented in *App. E BAM Sentences* on page 127.

NMEA 0183 over UDP

The LT-4100 system is supporting transmission of NMEA 0183 sentences (GNSS position information) via the LAN or Bluetooth interface. The supported protocol is UDP (only broadcast).

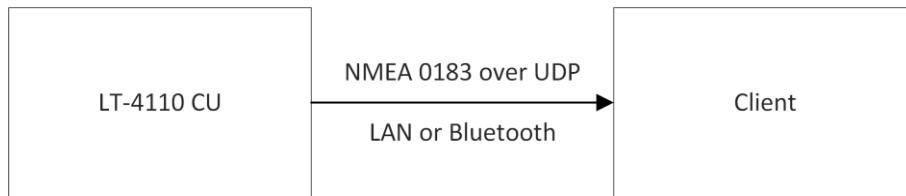

Figure 106: NMEA 0183 over UDP (broadcast)

The IP destination address will always be the local broadcast address of the LAN or BT network. I.e., if the configured LAN network address/mask is 192.168.1.0/24 the destination address will be 192.168.1.255.

The UDP destination port is user configurable, see Table 24.

UDP broadcast Port Configuration	
Interface	Port Number
LAN	1 to 65535
Bluetooth	1 to 65535

Table 24: UDP Broadcast Port Configuration

The configuration of the NMEA 0183 over UDP is illustrated in section *GNSS and BAM* on page 110. The Talker ID of the NMEA 0183 sentences can be changed by changing the configuration of the GNSS Receiver.

NOTE: Currently it is only possible to send NMEA 0183 sentences (GNSS position information) on one interface at a time. I.e., selecting CU LAN will disable GNSS on the RS-422 interface and vice versa.

Web server

The LT-4110 Control Unit has a built-in webserver, which can be accessed from the Ethernet (RJ45) interface from the back side of the control unit. A PC must be connected to the control unit, either directly by connecting an Ethernet cable between a PC and the LT-4110 Control Unit, or by connecting the LT-4110 Control Unit to a Local Area Network (LAN), to where the PC is connected.

NOTE: The IP address allocated to the LT-4110 Control Unit, is shown in the GUI (Menu -> System -> Network: IP Address).

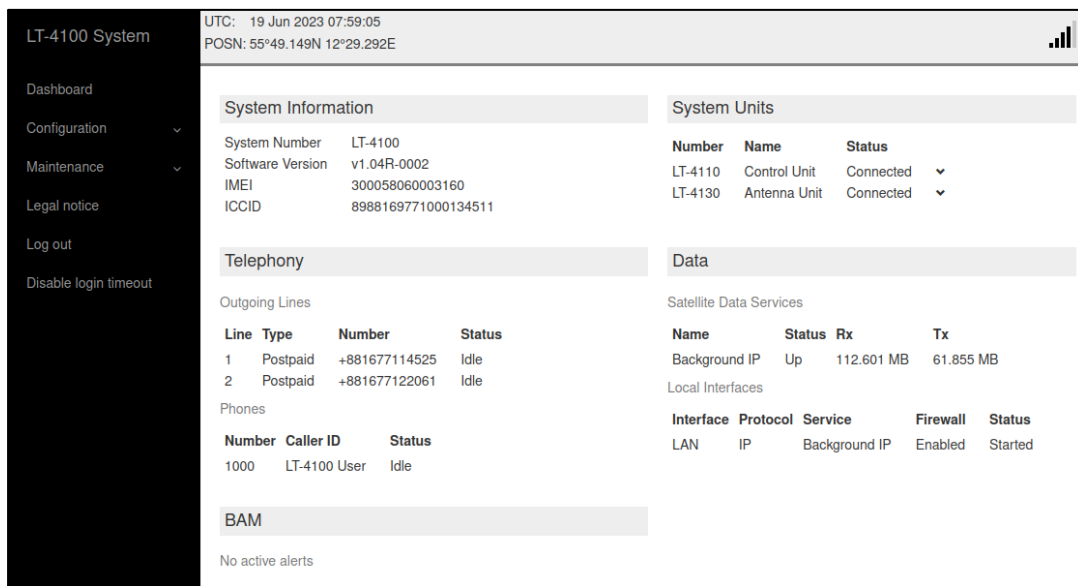

Figure 107: Web server (System dashboard)

The functionality of all web pages is described in further detail in the following sections. Some of the sections will refer to other sections in this User & Installation Manual, e.g. hardware interfaces.

NOTE: All web pages functionality will be described in detail for the LT-4100 system. It is the intention that the web pages should be used during the installation and configuration of the system. During normal operation of the system, it should not be necessary to access the web pages.

Accessing the built-in web server

To access the built-in web server of the LT-4100 system, please complete the following steps:

1. Connect the LT-4110 Control Unit directly to a PC using an Ethernet cable, or connect the LT-4110 Control Unit to a Local Area Network (LAN), where a PC is connected.
2. Identify the IP address that is assigned to the LT-4110 Control Unit. The IP address can be read out from the display (MENU -> System -> Network: IP Address). The IP address is valid if the 'Link Status' is showing 'Up'. The IP address is assigned dynamically by a DHCP server.
3. From the PC, start a browser (e.g. Microsoft Edge, Explorer, Chrome, etc.) and type in the IP address, which was identified in the LT-4110 Control Unit (e.g. 10.1.10.39).
4. The browser might show you a warning about an invalid web server certificate, as illustrated in Figure 108. Make sure, that you have typed in the correct IP address.
5. Press 'Details' and you will be presented for an extended page view (including a link), which will direct you to the LT-4100 system dashboard 'Go on to the webpage (Not recommended)'.
6. You will now see the LT-4100 system dashboard.

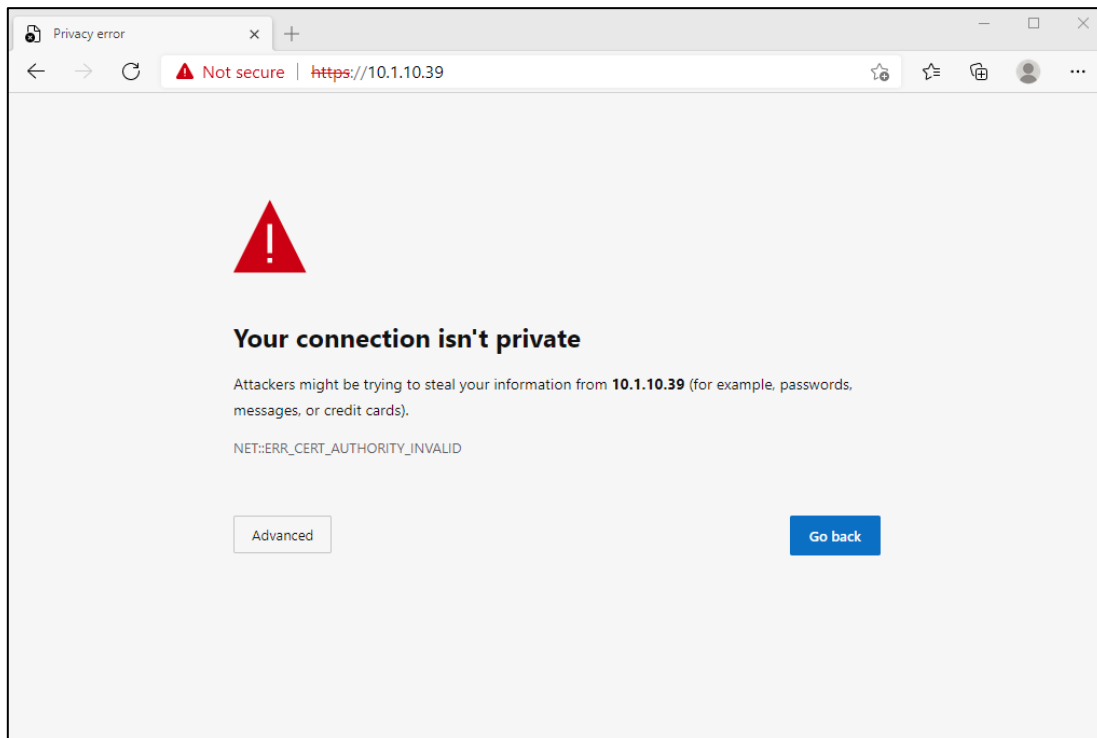

Figure 108: Accessing the built-in web server ("This site is not secure").

Dashboard

The dashboard shows details about the two main units, which forms the Satcom system: the LT-4110 Control Unit and the LT-4130 Antenna Unit. If the antenna unit is connected properly to the control unit, then the antenna unit will be visible on the web server dashboard, as illustrated in Figure 109. Otherwise only the control unit will be visible. For each unit, the following information will be available: unit number, unit name, unit part number, unit serial number, and software version. The antenna unit will automatically be updated with the software version, which is available in the control unit.

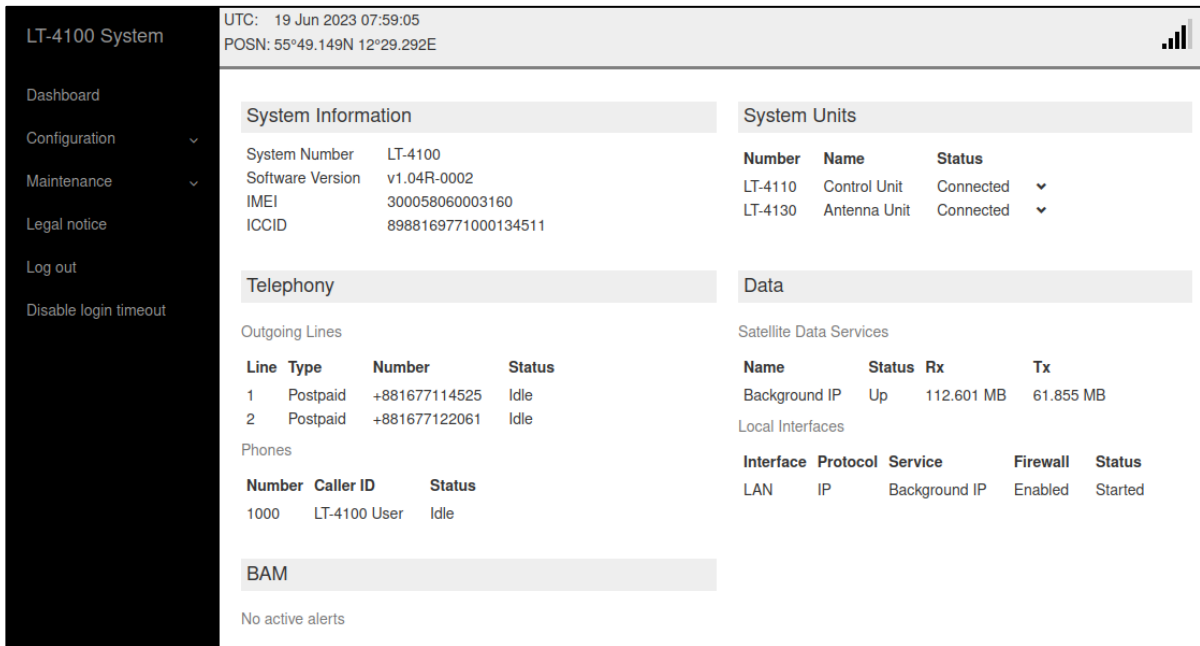

Figure 109: LT-4110 Control Unit - built-in web server (dashboard).

The web server has the following web pages:

- Dashboard
- Configuration
- Maintenance
- Legal notice
- Log out
- Disable login timeout

Configuration

After installation of the LT-4100 system has been properly performed, the system is fully operational. In this section there will be a description of system settings which are configurable from the Web Server.

Under Configuration, the following webpages are available:

The screenshot displays the configuration interface for the LT-4100 system. At the top, it shows the system name 'LT-4100 System', the current time 'UTC: 19 Jun 2023 07:59:34', and the location 'POSN: 55°49.150N 12°29.292E'. A signal strength indicator is visible in the top right corner.

The main content area is divided into several sections:

- System Information:**

System Number	LT-4100
Software Version	v1.04R-0002
IMEI	300058060003160
ICCID	8988169771000134511
- System Units:**

Number	Name	Status
LT-4110	Control Unit	Connected
LT-4130	Antenna Unit	Connected
- Telephony:**

Outgoing Lines

Line	Type	Number	Status
1	Postpaid	+881677114525	Idle
2	Postpaid	+881677122061	Idle

Phones

Number	Caller ID	Status
1000	LT-4100 User	Idle
- Data:**

Satellite Data Services

Name	Status	Rx	Tx
Background IP	Up	112.601 MB	61.855 MB

Local Interfaces

Interface	Protocol	Service	Firewall	Status
LAN	IP	Background IP	Enabled	Started
- BAM:**

No active alerts

The left sidebar contains the following navigation menu items: Dashboard, Configuration (expanded), Authentication, Network, Bluetooth, IP Data, Telephony, Contacts, Tracking, External I/O, GNSS and BAM, Reset, Maintenance, Legal notice, Log out, and Disable login timeout.

Figure 110: Web server (Configuration)

- Authentication
- Network
- Bluetooth
- IP Data
- Telephony
- Contacts
- External I/O
- GNSS and BAM
- Reset

Authentication

The LT-4100 system supports authentication on the web server.

The default password for the User = admin is Password = admin. The LT-4100 system will always be delivered from the factory with this default password.

NOTE: It is recommended that the user of the LT-4100 system changes the default password during the installation of the system, so that a random user on the network do not have access to the web server.

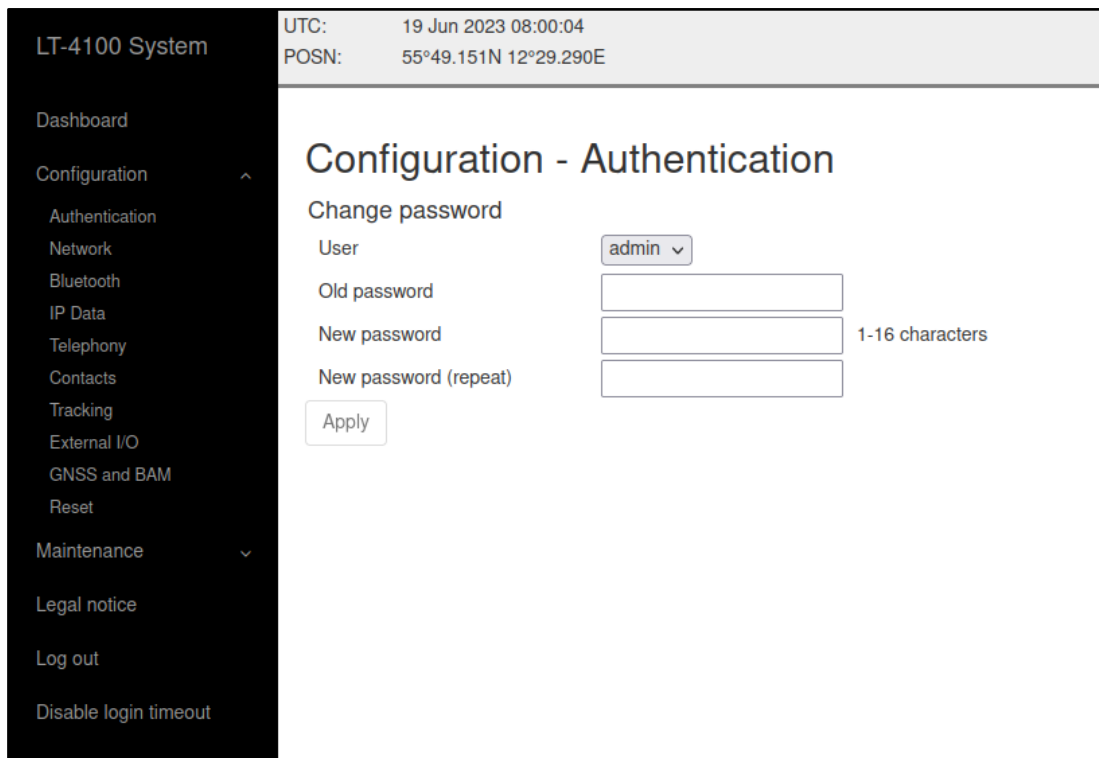

The screenshot displays the web server interface for the LT-4100 system. On the left is a dark sidebar menu with the following items: Dashboard, Configuration (expanded), Authentication, Network, Bluetooth, IP Data, Telephony, Contacts, Tracking, External I/O, GNSS and BAM, Reset, Maintenance (expanded), Legal notice, Log out, and Disable login timeout. The main content area has a header showing 'UTC: 19 Jun 2023 08:00:04' and 'POSN: 55°49.151N 12°29.290E'. Below the header is the title 'Configuration - Authentication' and a section titled 'Change password'. This section contains a 'User' dropdown menu set to 'admin', three input fields for 'Old password', 'New password' (with a '1-16 characters' label), and 'New password (repeat)', and an 'Apply' button.

Figure 111: Web server - Authentication

If the authentication password is changed from default and forgotten, then the authentication password can be reset from the display (MENU -> Settings -> Reset Options: Reset Web Authentication). Remember to change the authentication password away from the default password as soon as it has been possible to re-enter the web server. The Reset Web Authentication is further described and illustrated in *Settings* on page 66.

Network

The LT-4100 system supports the most common network configurations for Local Area Network (LAN). The LT-4100 system has one Ethernet (RJ45) interface, which is described in *Ethernet RJ45 (LAN)* on page 26.

The following network configuration modes will be described in this section:

- DHCP client
- DHCP server
- Static

The default network configuration mode for the Ethernet interface is DHCP client.

NOTE: In DHCP client mode, Link-local is supported, in order to connect another ‘passive’ IP-device

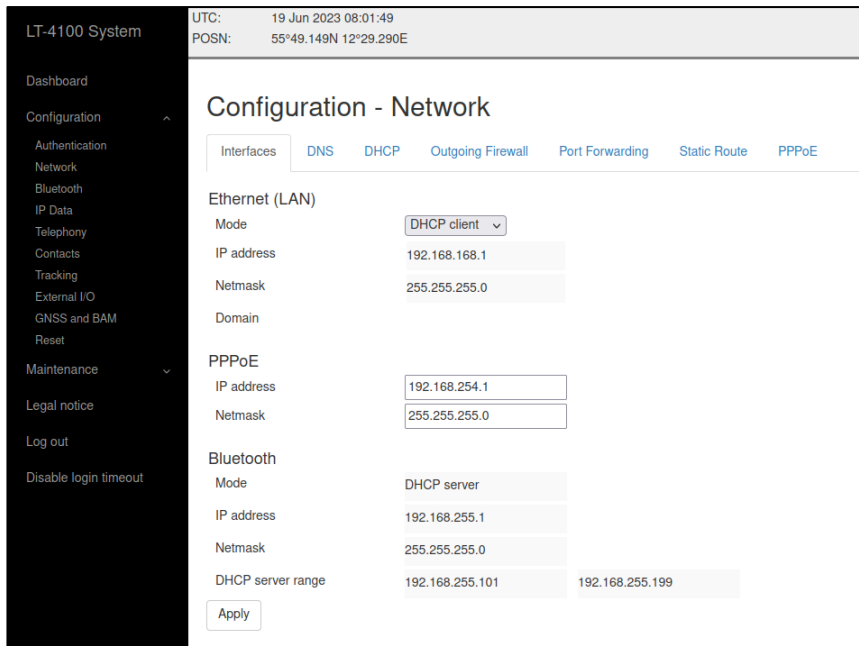

Figure 112: Web server - Network

(e.g. a PC) directly to the LT-4110 Control Unit. Expect the LT-4110 Control Unit to get the IP-address: 169.254.1.1.

NOTE: The IP-address of the LT-4110 Control Unit is always displayed in the UI (MENU -> System -> Network), see details in *System* on page 74

NOTE: If the user changes DNS all clients needs to be rebooted as changes does not apply automatically

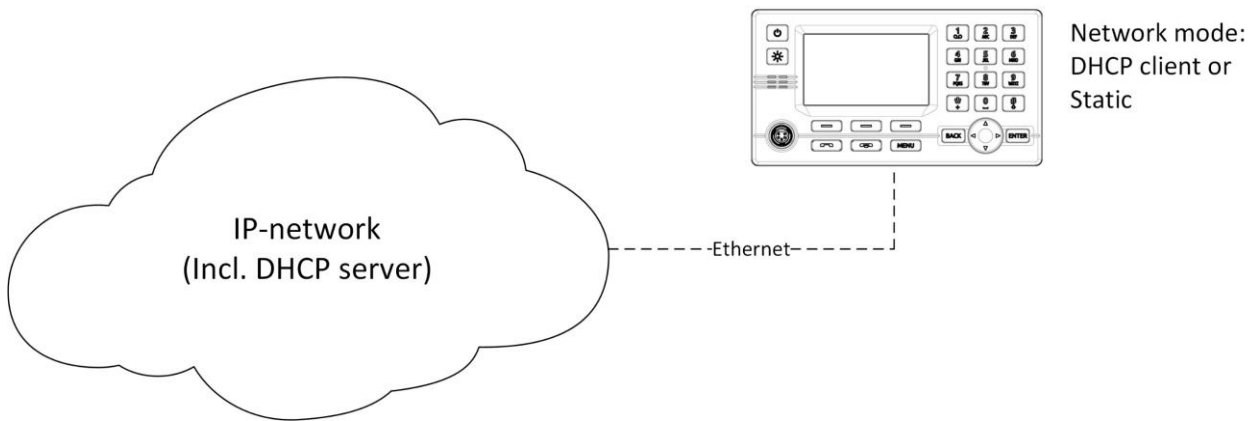

Figure 113: Web server - Network

If the LT-4100 system is connected to a local network as illustrated in Figure 113, where a DHCP server is already available, then the LT-4100 system must be configured to either DHCP client or Static mode. The Static mode can be used, if it is required that the IP-address of the LT-4110 Control Unit must never change.

The LT-4100 system has two reserved network ranges, which are documented in Table 25.

Reserved Network Ranges	
Reserved	Sub-nets
Reserved External	192.168.255.0/24 - i.e. 192.168.255.0 netmask 255.255.255.0
Reserved Internal	172.27.0.0/16 - i.e. 172.27.0.0 netmask 255.255.0.0

Table 25: Reserved Network Ranges

IMPORTANT: Do not connect the LT-4100 System to any external IP networks, which are not trusted. The LT-4110 Control Unit has Firewall rules configured on all Ethernet ports to avoid unwanted IP traffic.

DHCP client

The DHCP client mode is the configuration of the LT-4110 Control Unit from the factory. The DHCP client mode must be used, if the IP network already has a DHCP server available.

DHCP Server

The DHCP server mode must be used when connecting the LT-4110 Control Unit directly to another IP-device or local network, where no DHCP server is offered, and where it is required that a DHCP server is offered for assigning IP-addresses to network clients. The DHCP server mode setting is illustrated in Figure 114.

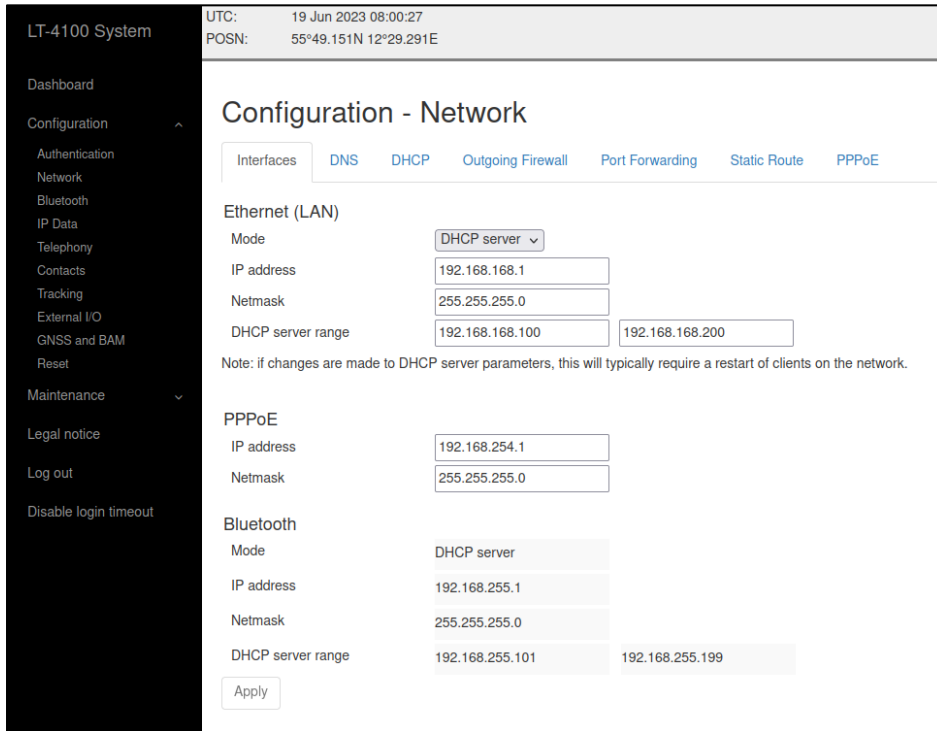

Figure 114: Web server – Network (DHCP server mode)

NOTE: A user scenario for configuration the DHCP server mode is when e.g., connecting IP-based communication devices: Analogue Phone Adapter, SIP Phones, or the RedPort Optimizer directly to the LT-4110 Control Unit via the Ethernet interface. Connecting an Analogue Phone Adapter is further described in *Analogue Phone Adapter* on page 52.

NOTE: If the user changes DNS all clients’ needs to be rebooted as changes does not apply automatically

Static

The Static mode must be used when the IP address of the LT-4110 Control Unit must never change. Typically used, if connecting the LT-4110 Control Unit to an IP network, where a DHCP server is already available, and where it is important that the IP address assigned for the LT-4110 Control Unit is never changed. The web server static setting is illustrated in Figure 115.

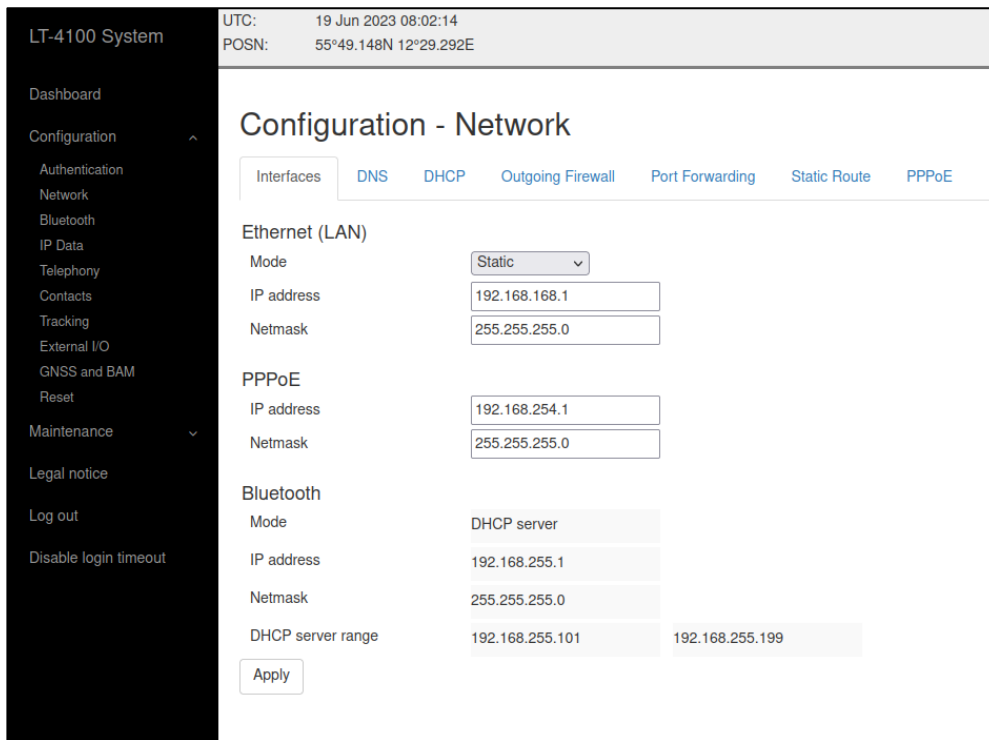

Figure 115: Web server – Network (Static mode)

NOTE: If the user changes DNS all clients' needs to be rebooted as changes does not apply automatically

DNS

The LT-4100 system contains a caching recursive DNS server used to resolve names in the local domain. The system also contains two references to external DNS servers which are used to resolve names in the other domains. For configuration of the DNS servers see Figure 116.

NOTE: If the outgoing firewall is enabled the LT-4100 system will only allow domain names present in any firewall rules to be resolved externally. See Outgoing Firewall later in this section.

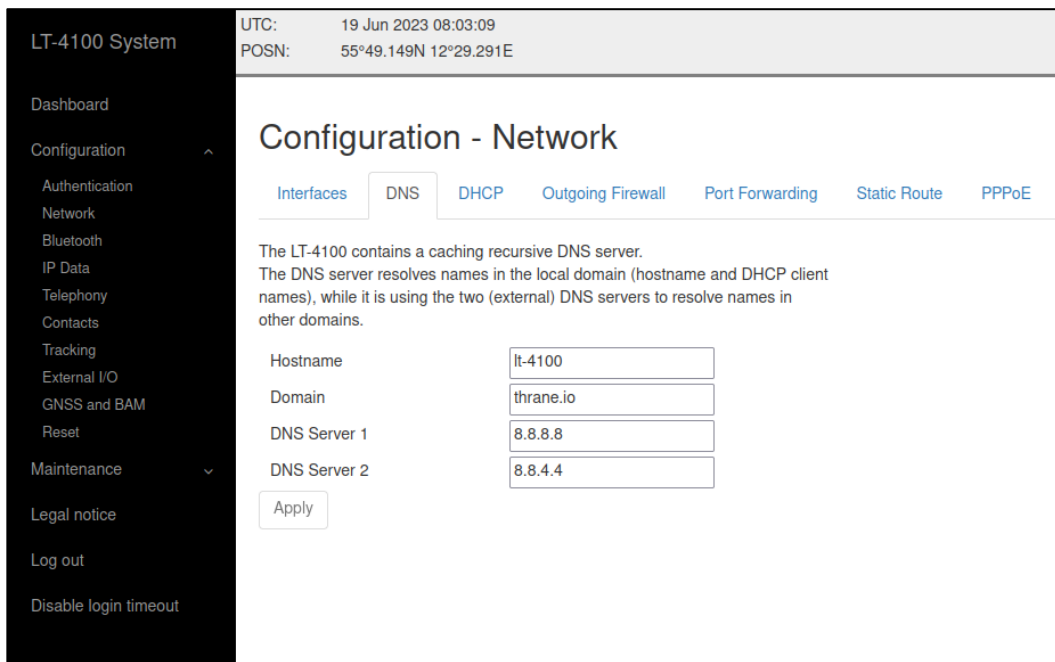

Figure 116: Web server – Network (DNS)

DHCP

The DHCP tab shows the active DHCP leases. This includes LAN clients if ethernet is configured for DHCP server mode.

The screenshot shows the web interface for the LT-4100 System. On the left is a navigation menu with options like Dashboard, Configuration, Authentication, Network, Bluetooth, IP Data, Telephony, Contacts, Tracking, External I/O, GNSS and BAM, Reset, Maintenance, Legal notice, Log out, and Disable login timeout. The main content area is titled 'Configuration - Network' and has several tabs: Interfaces, DNS, DHCP (selected), Outgoing Firewall, Port Forwarding, Static Route, and PPPoE. Below the tabs is a table of active DHCP leases:

Host Name	MAC Address	Assigned IP	Lease Time	Interface
KTL-LPC	00:2b:67:16:53:63	192.168.168.181	23:57:43	Ethernet

Figure 117: Web server – Network (DHCP)

Outgoing Firewall

Configuring the outgoing firewall allows the LT-4100 system operator to block all outgoing user network traffic apart from specified exceptions.

When setting up the Outgoing firewall the user needs to supply the system with: a name for the exempted network traffic address and a destination domain e.g. Predictwind.com, see Figure 118 below.

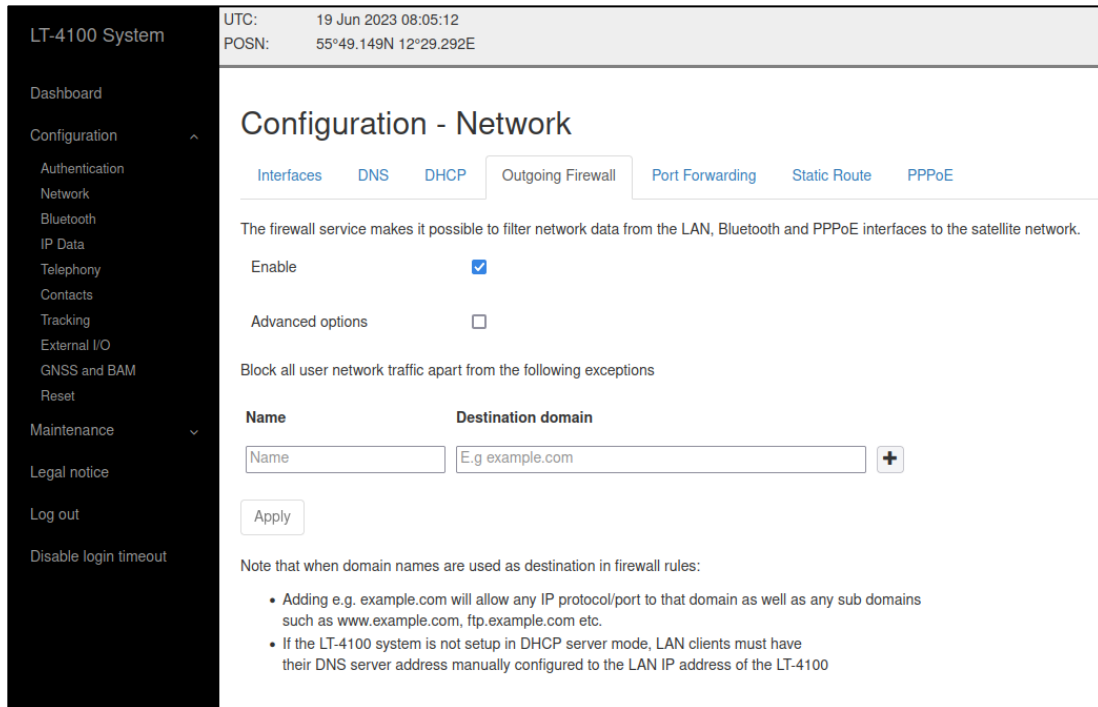

Figure 118: Web server – Network (Outgoing firewall)

NOTE: If the LT-4100 system is not setup in DHCP sever mode, LAN clients must have their DNS server address manually configured to the LAN IP address of the LT-4100.

If the user wants more configurability, then the Advanced options ticker can be clicked, allowing the user to configure, a name, a Destination domain or IP address, a chosen protocol, and which port to use. Protocol and Port selection can either be input or set to 'any'. See Figure 119 below for details.

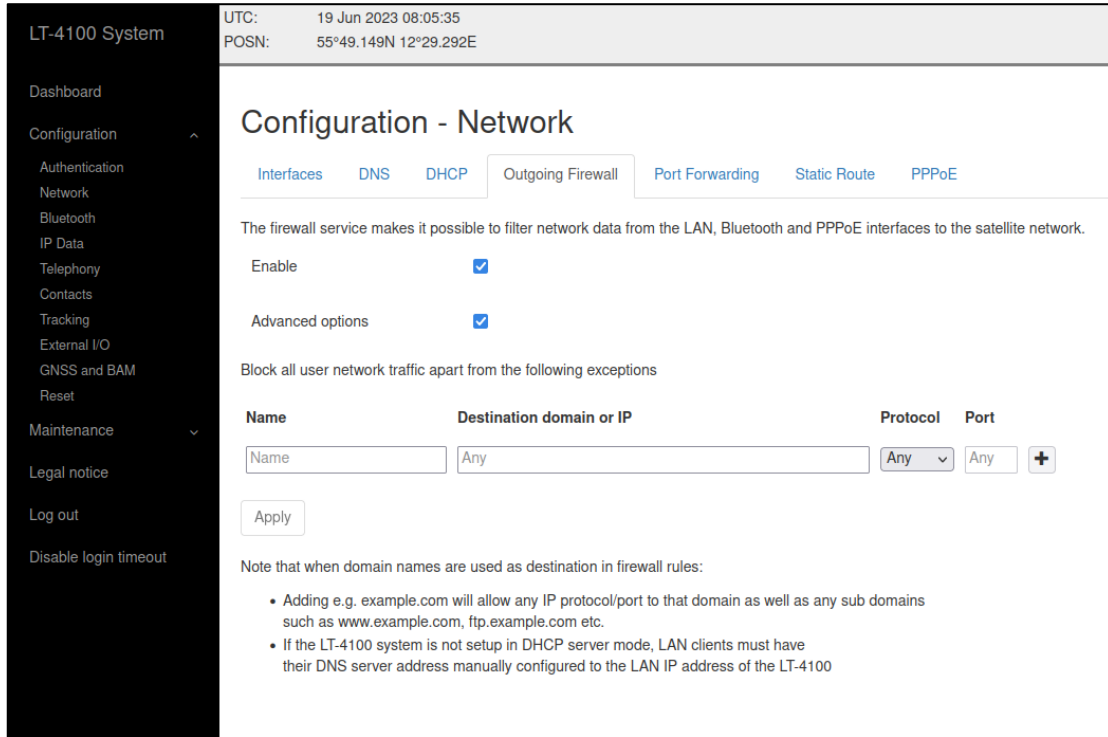

Figure 119: Web server – Network (Outgoing firewall, advanced options)

Port forwarding

Port forwarding allows the user of the LT-4100 system to access IP data running on specific equipment which is connected to the LT-4100 LAN port

When setting up port forwarding for the LT-4100 system the user needs to establish port forwarding rules. These user needs to configure the external port, the local IP address, the port, and the chosen protocol.

To ensure smooth operation after setting up a port forwarding rule, the IP address(es) of the user equipment that shall be reachable remotely should be statically assigned. If the LT-4100 is configured as DHCP server make sure to assign IP addresses outside the DHCP server range.

An example of a configured port forwarding rule can be seen on Figure 120. There a PC running a web service on tcp port 8080 is connected to the LT-4100 LAN port. The PC is statically assigned the IP address 192.168.1.202. Adding this port forwarding rule allows access to the Web service.

To verify whether the rule was set up correctly and the web service is accessible remotely visit the URL <https://<public-IP-of-terminal>:8080>

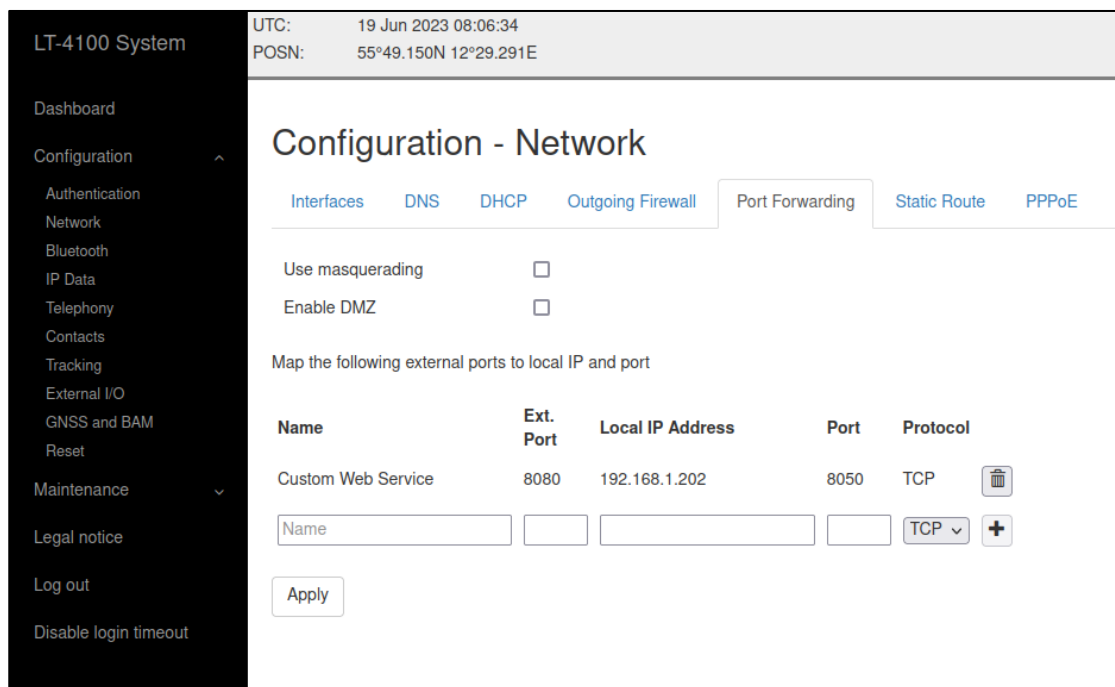

Figure 120: Web server – Network (Port forwarding)

IMPORTANT: TCP port 443 is reserved by the LT-4100 terminal and may not be used as external port in port forwarding rules and will not be forwarded to any configured DMZ host.

NOTE: Remember to click 'Apply' after adding the rule to the table

Port forwarding DMZ

It is possible to setup a DMZ, which may be used to unconditionally forward all incoming IP traffic to one host on the LAN. If a dedicated firewall is connected to the LT-4100 LAN port the user may choose to forward all incoming IP traffic to the IP address of the firewall for further processing. To enable DMZ check the “Enable DMZ” checkbox and specify the IP address on the LAN to forward to as shown on Figure 121. Note that when enabling DMZ any port forwarding rules configured will not be active.

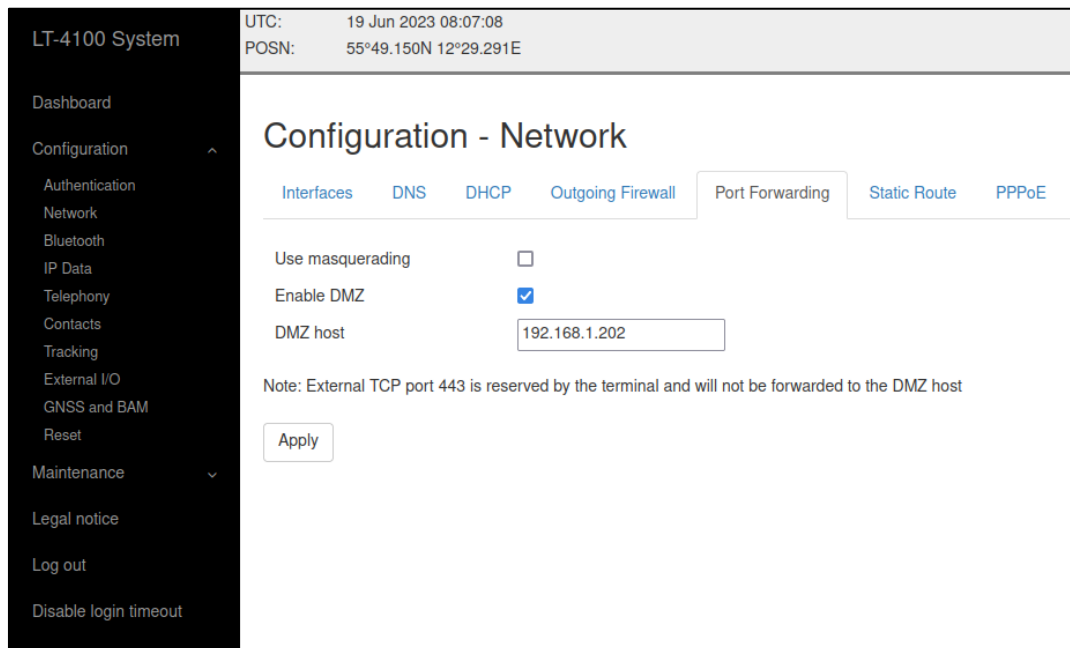

Figure 121: Web server – Network (Port forwarding (DMZ))

Masquerading

It is possible to mask the IP address of any incoming IP connection using the masquerade option. By ticking off the ‘Use masquerading’ box the LT-4100 will replace the source IP address of the incoming IP connection with the IP address of the LT-4100 terminal LAN port before it is forwarded to the configured destination. This is shown on Figure 122.

Masquerading may be used if the PC/user equipment being the target of port forwarding rules (or configured as DMZ host) has another preferred route to the internet e.g. via a VSAT solution etc. In that case the PC will – if masquerading is not enabled – chose to send its replies via that route instead of via the LT-4100. By using masquerading the host is forced to send its replies via the LT-4100 as the LT-4100 IP address is the only visible IP address to the target/host. Masquerading is usable both in port forwarding mode and port forwarding with DMZ mode.

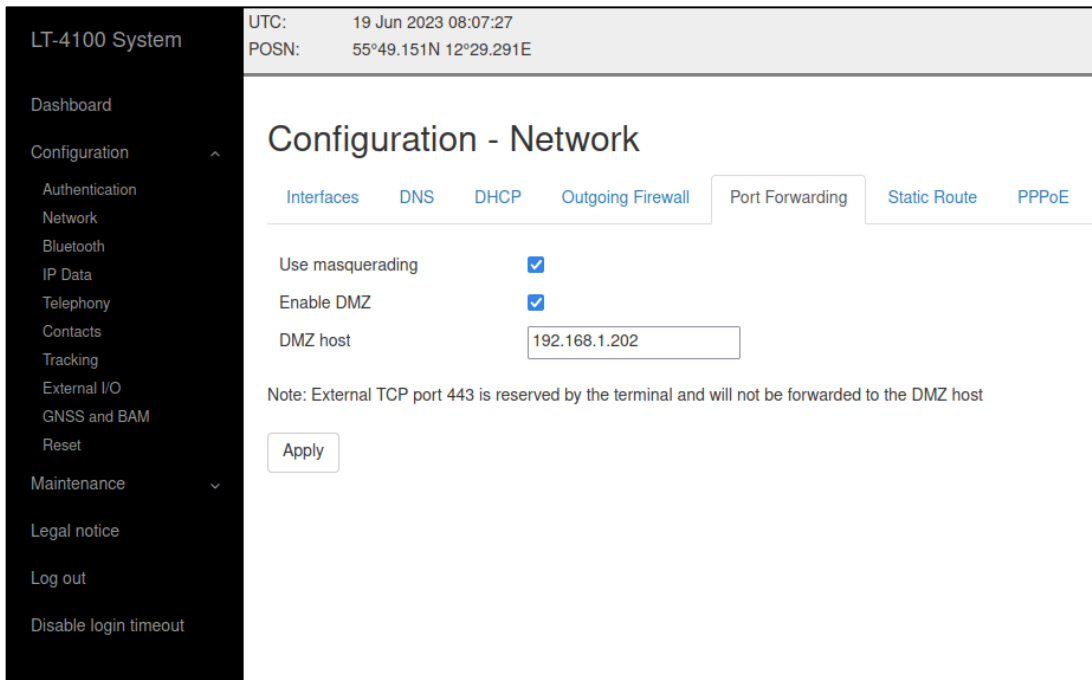

Figure 122: Web server – Network (Port forwarding (Masquerading))

Static Route

It is possible to route IP data to other network segments on the LAN by using the Static Route feature of the LT-4100 system. This allows the user to configure rules containing the destination IP address and the used gateway.

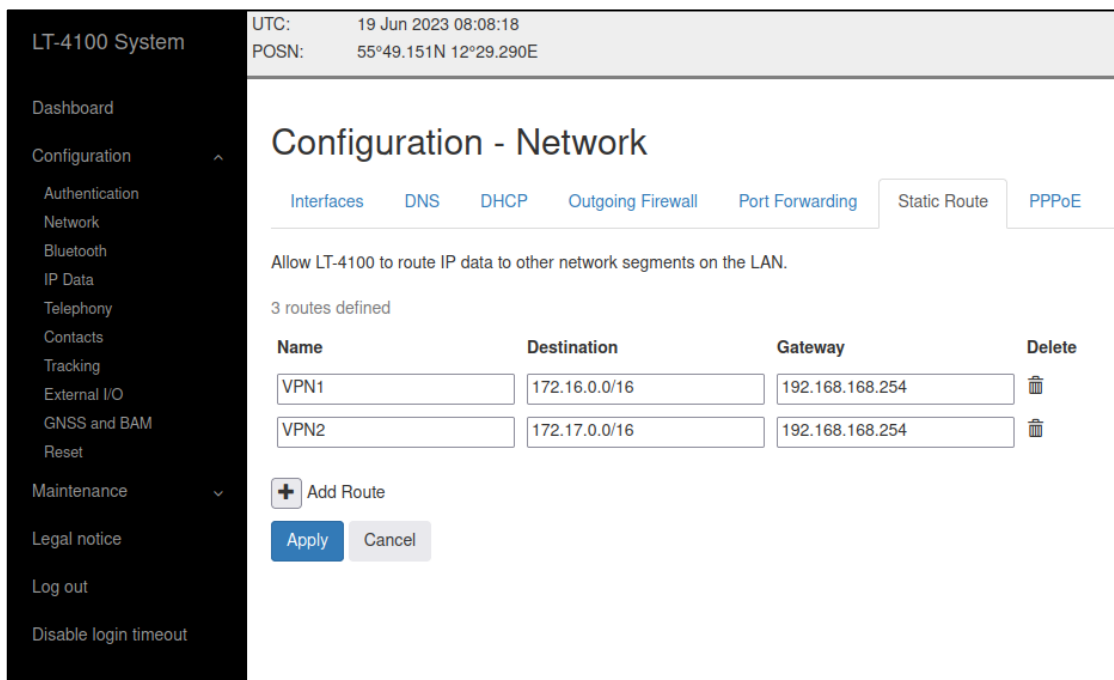

Figure 123: Web server – Network (Static Route)

PPPoE

It is possible to setup the PPPoE service for the LT-4100 system, which makes it possible for a connected network device to create a point-to-point connection to the internet. As described in *PPPoE* on page 59 , the rules regarding outgoing firewall can be enabled for the PPPoE connection.

The PPPoE connection must be configured by setting up the Service name, Access Concentrator (AC) name, User name and Password. See Figure 124 for configuration.

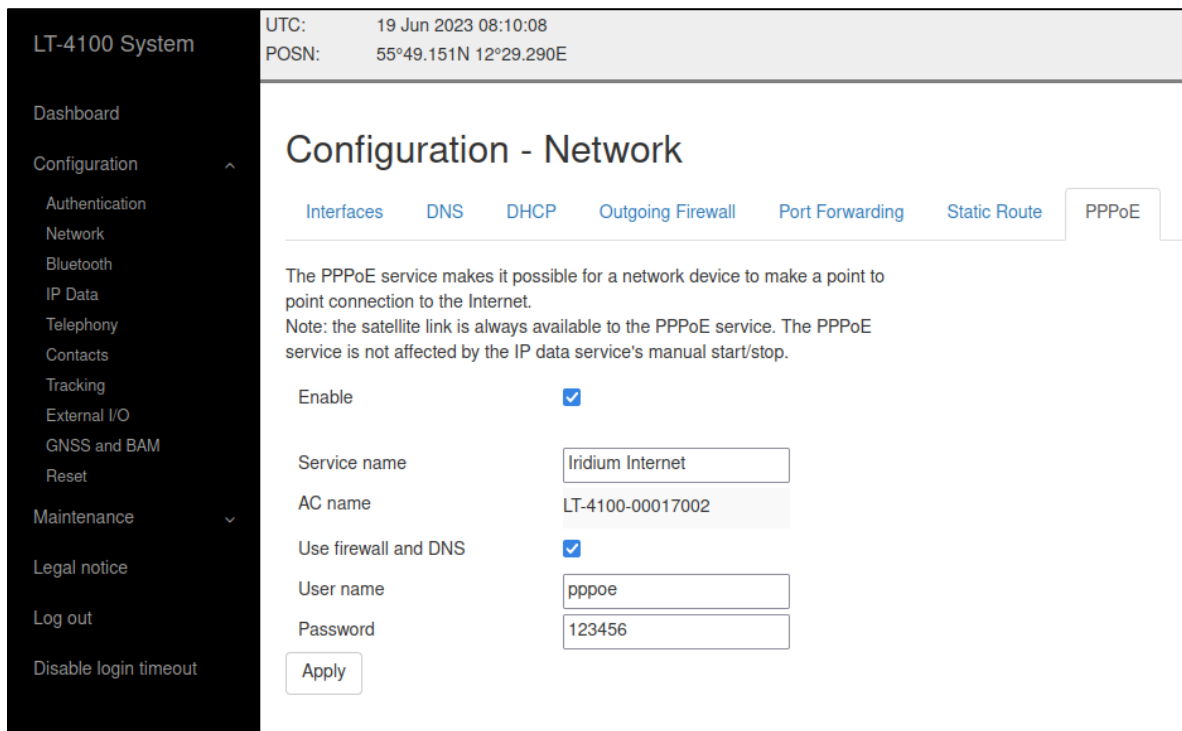

Figure 124: Web server – Network (PPPoE)

Remote Access

After enabling Remote management from the LT-4110 Control Unit GUI, test the connection by visiting the Public URL of the terminal (e.g. <https://203.0.113.1>) from a device having a public IP address configured for remote access in Iridium’s firewall and verify the login page of the LT-4100 terminal as shown on Figure 125.

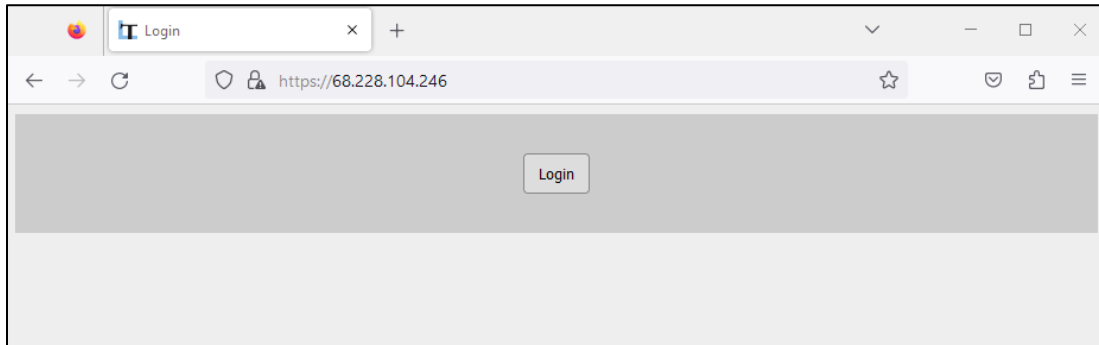

Figure 125: Web server – Remote Access

NOTE: Remote Access has only been tested with a Firefox browser.

NOTE: As the upload speed of a Certus 100 terminal is low compared to normal internet connections, accessing the web management interface of the LT-4100 via the satellite connection may require some patience compared to normal web browsing experience.

WARNING: If the default password for the admin user has not been changed it is highly recommended that it is changed before enabling Remote Access.

When accessing the LT-4100 web interface via remote management, web pages that normally automatically refresh when connected to the terminal via LAN will instead provide a ‘Refresh page’ button at the top of the webpage to prevent excessive IP data usage. This is illustrated on Figure 126.

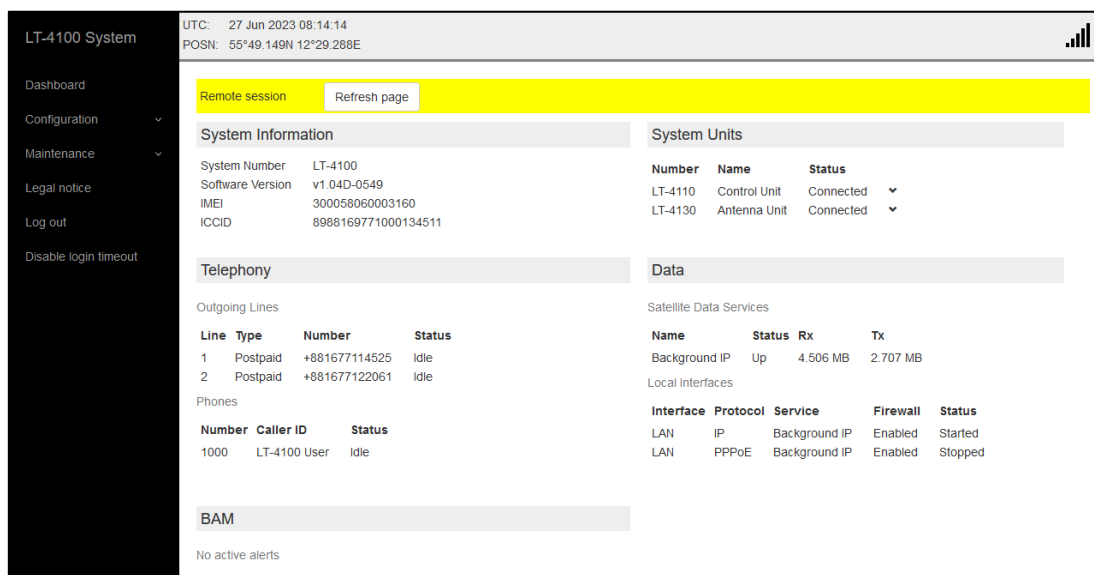

Figure 126: Web server - Remote Access

Bluetooth

The LT-4100 system has a Bluetooth transceiver built into the LT-4110 Control Unit. The LT-4100 system is currently only supporting the Bluetooth profile: Personal Area Network (PAN), the Headset profile is not supported. It is possible to enable the Bluetooth transceiver and change the device name in the web server, as illustrated in Figure 127.

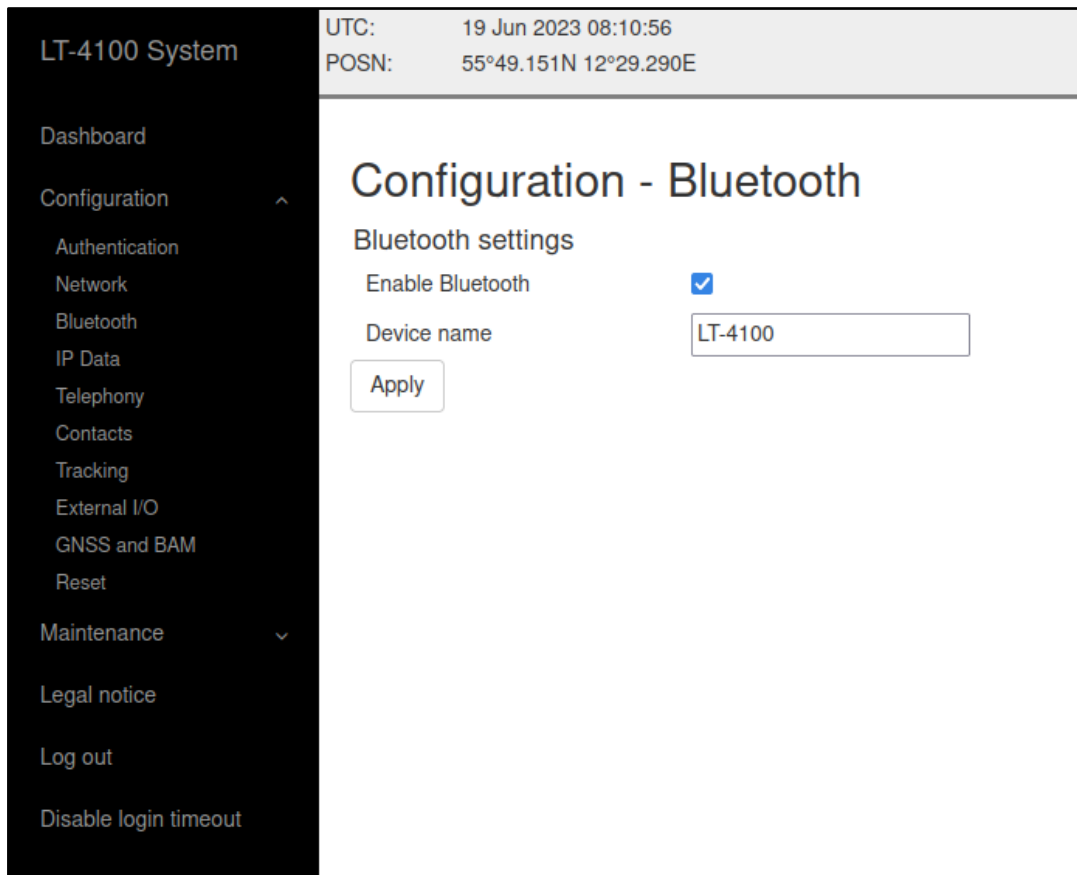

Figure 127: Web server - Bluetooth

Bluetooth information is also available via the UI, which is described in *Settings, Bluetooth* on page 66.

NOTE: The built-in Bluetooth module and functionality will not be available in future production of the LT-4110 Control Unit due to manufacturer shortage and component obsolescence. In the display / GUI (MENU -> Settings -> Bluetooth) it can be verified if the Bluetooth module is mounted or not (the Bluetooth submenu will only be shown if the module is mounted).

IP Data

In addition to configuring outgoing Data activation on the LT-4110 Control Unit as described in *System Submenus, Settings* it is also possible to control whether Always On or Manual Start/Stop is used on the LT-4100 System Web interface. There is no difference whether this is managed on the LT-4110 Control Unit or on the web interface. The process is shown on Figure 128, where Mode can be set to 'Always On' or 'Manual Start/Stop'.

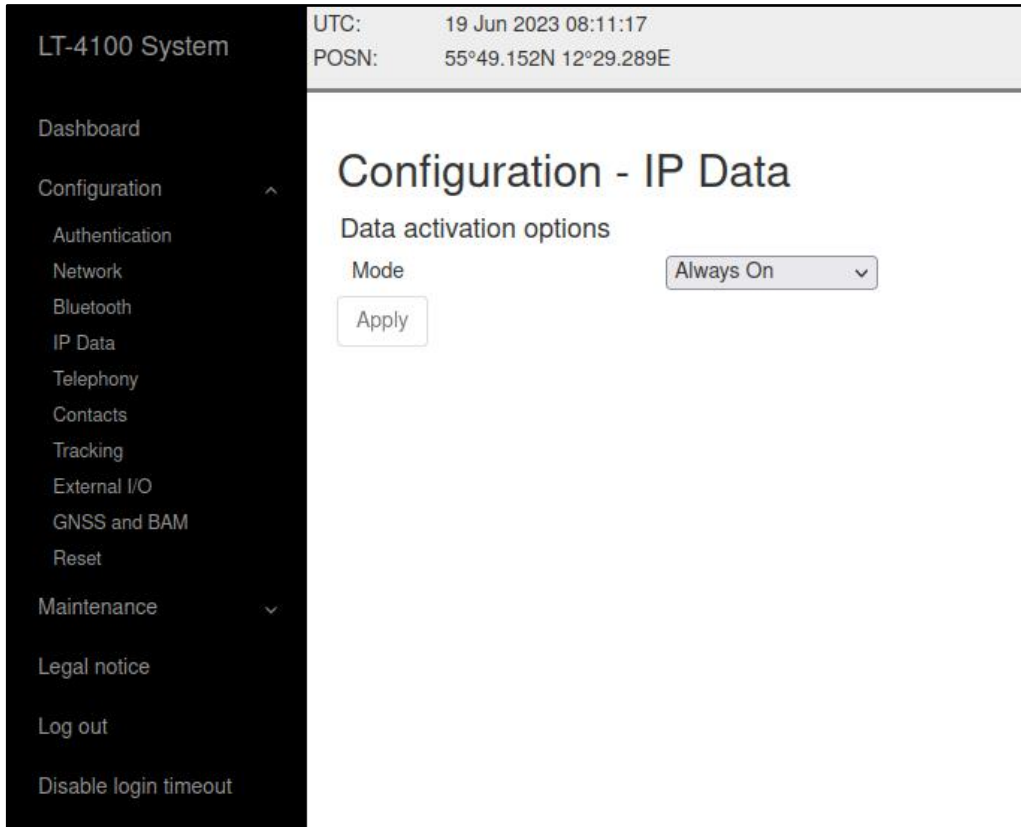

Figure 128: Web server – IP Data

Telephony

The LT-4100 System has a built-in PBX trunk (SIP), which supports internal and external satellite calling. The LT-4100 system supports 2 x Iridium satellite voice channel. The PBX trunk (SIP) can be accessed via Ethernet, RJ45 or via the Bluetooth interface. Up to 8 external SIP devices can be registered in the PBX trunk. All the enabled voice channels can be configured for either or both Voice Line 1 and 2. The web server, configuration - Telephony is illustrated in Figure 129.

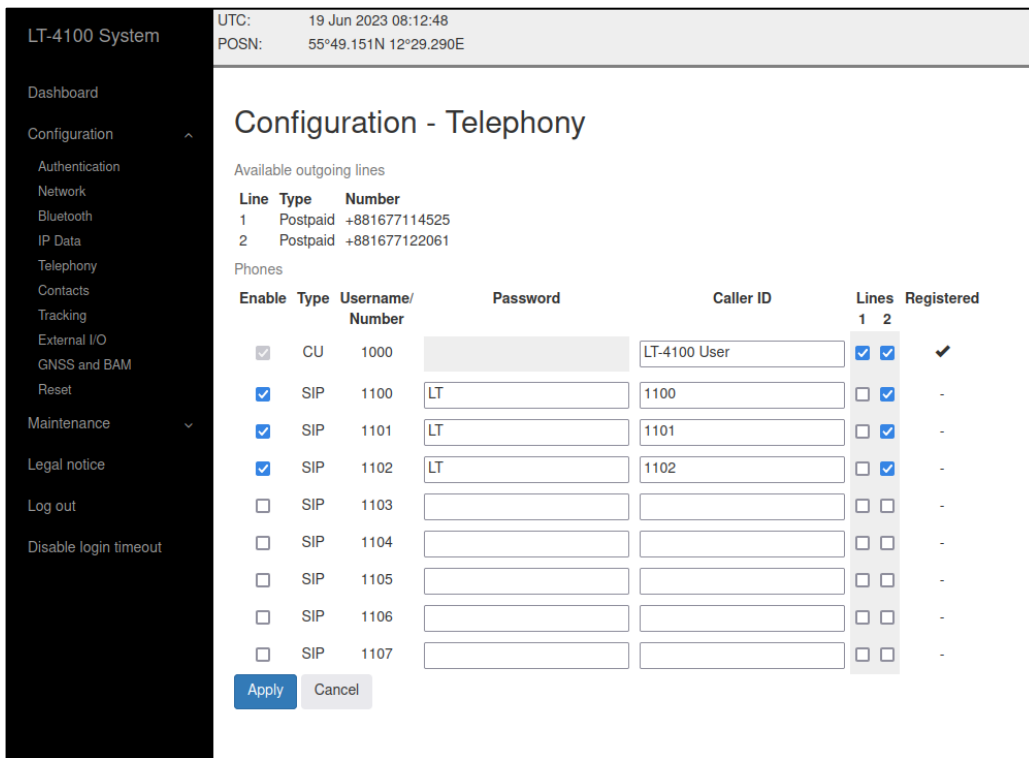

Figure 129: Web server - Telephony

On Figure 129 it is possible to see the two voice lines, their type (post-paid) and the respective phone numbers for line 1 and line 2.

In the LT-4110 Control Unit, UI display (MENU -> System -> SIP Phones) it is possible to get an actual status of the number of SIP devices and their registration status. This is further illustrated and described in *External SIP Phones* on page 50.

The following external applications requires a SIP configuration:

- Connection of ships PBX
- External SIP Phones
- External Analogue Phone Adapter
- SIP Softphones via built-in Bluetooth module
- SIP Softphones via external Wi-Fi Access Point (WAP)

Incoming calls to one of the two possible configurable Lines will be signaled to all phones configured for the specific line. If an incoming call is directed to Line 1, all Line 1 phones will ring, whereas Line 2 phones will not. The LT-4100 system supports call forwarding, such that Line 1 may be set up to forward to Line 2 and vice versa. It is possible to set up e.g., the CU to both Line 1 and Line 2.

Contacts

The user of the LT-4100 system can configure Contacts directly from the web server or from the LT-4110 Control Unit as described in *Phone* on page 63.. It is possible to both edit and create new contacts. The web server contact list is identical to the one seen on the LT-4110 Control Unit.

To add a new contact, press the “+” sign, then input: Name, Phone Number and/or Email. When finished inputting information press the Apply button.

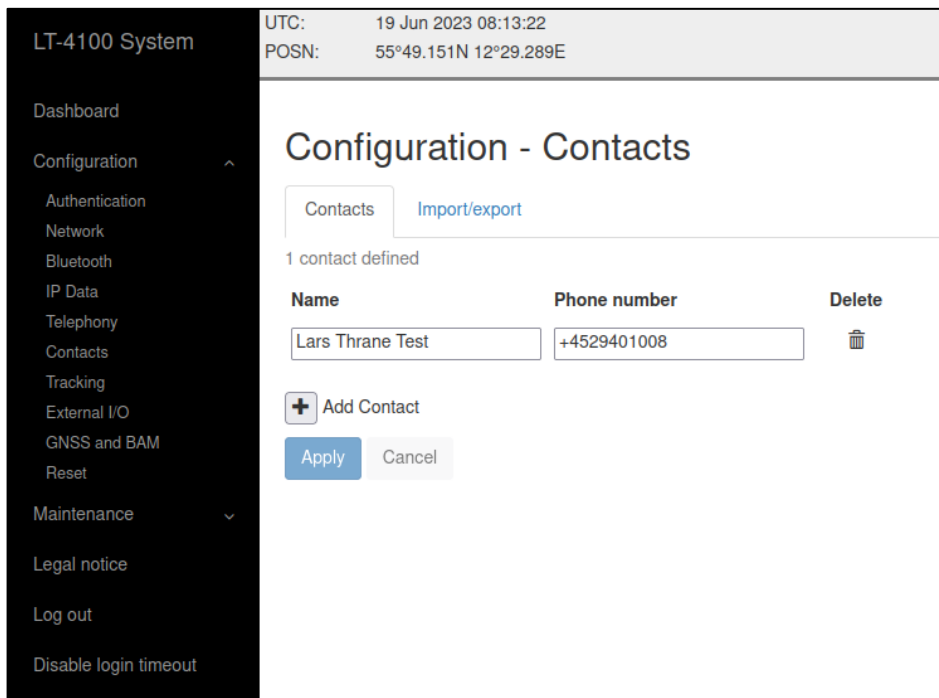

Figure 130: Web server - Contacts

NOTE: It is possible to edit contacts on the Web Server. To do so, edit Name, Phone number or Email address, and then press the Apply button.

It is possible to import and export contacts into the LT-4100 system. Note that the contact file must be using the Vcard format and must contain max 100 contacts. For operation see Figure 131 on page 108.

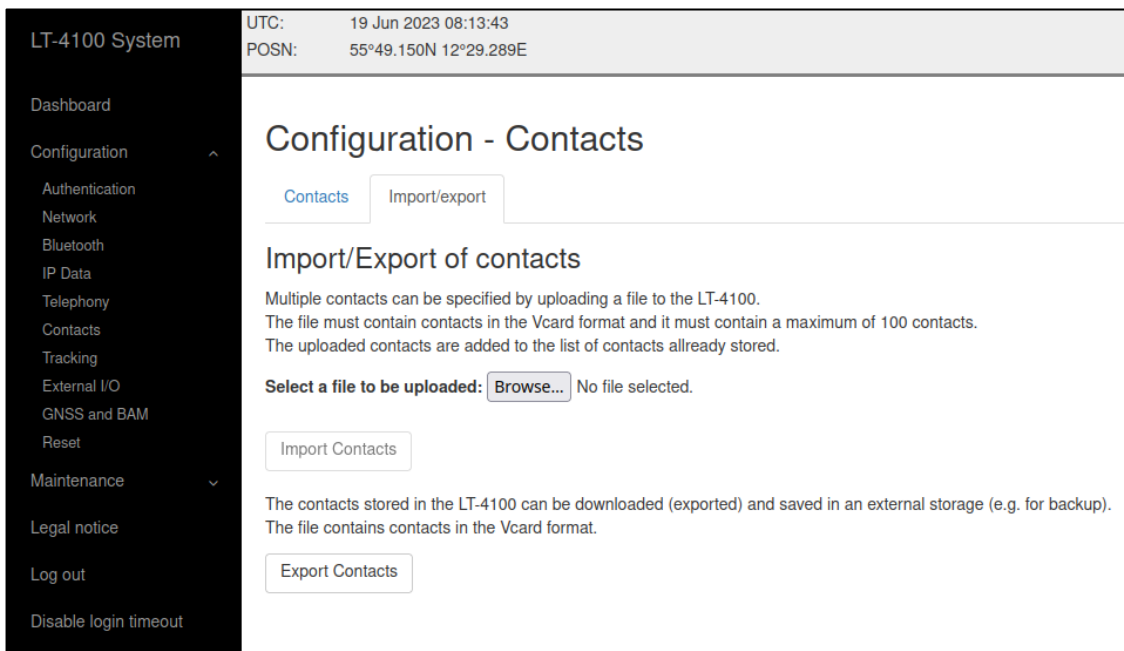

Figure 131: Web server – Contacts (Import/export)

External – I/O

The LT-4100 system support configuration of External I/O. The LT-4100 system has one input and one output supported in the AUX connector. The AUX connector is described in *Auxiliary (AUX)* on page 27. Figure 132 is illustrating the configuration of the External I/O.

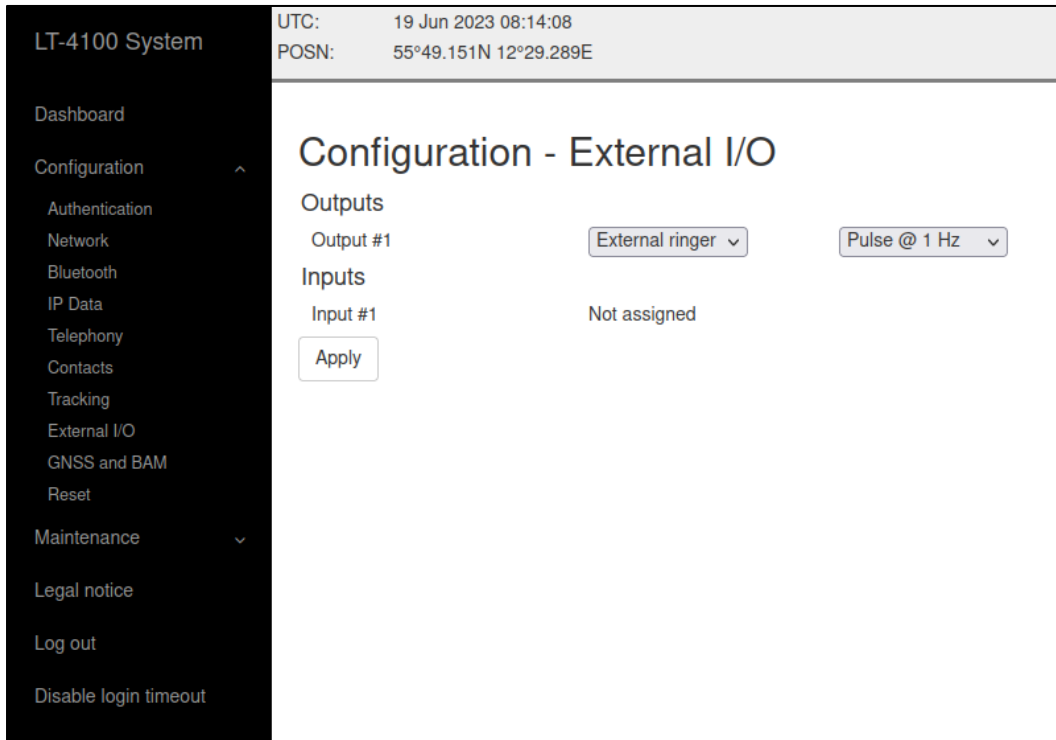

Figure 132: Web server – External I/O

Output

External I/O – Output Configuration	
Not assigned	
External Ringer	Level
	Pulse @ 0.5 Hz
	Pulse @ 1 Hz
	Pulse @ 2 Hz

Table 26: External I/O - Output

The External I/O output configuration options are listed in Table 26.

Input

The LT-4100 system is currently not supporting the External I/O input.

GNSS and BAM

The LT-4100 system has a built-in GNSS receiver located in the LT-4130 Antenna Unit. The GNSS receiver is used for time, date and position of the LT-4100 system, for example by the tracking application. The GNSS receiver can be configured to operate on different satellite systems (e.g. GPS only) - this can be managed under the GNSS module, as illustrated in Figure 133.

It is possible to configure the following functionality: GNSS and BAM on the LT-4110 Control Unit (CU - AUX) interface.

This section describes the following configuration options:

- GNSS module
- GNSS (output of NMEA 0183 sentences)
- Bridge Alert Management (BAM)

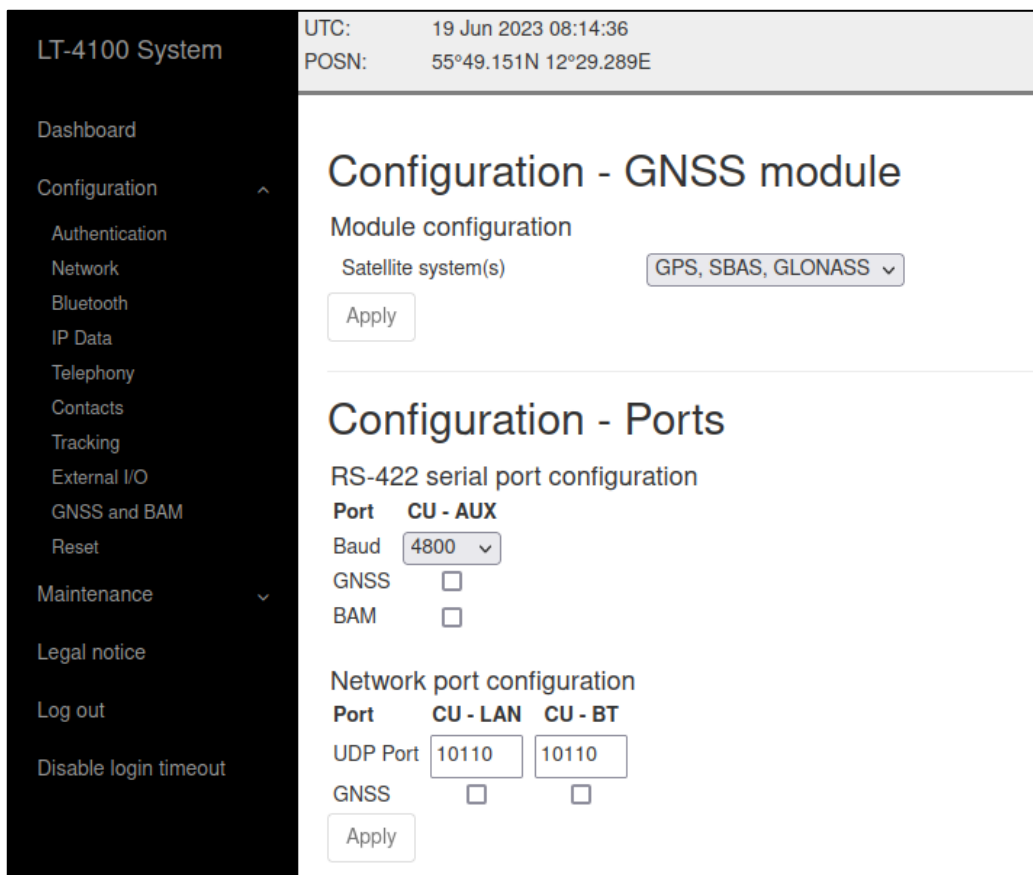

Figure 133: Web server – GNSS and NMEA output

NOTE: The Port configuration illustrated above in Figure 133 for GNSS and BAM supports the following baud rates: 4800, 9600, and 38400. The port is bi-directional RS-422. Only BAM can receive data.

GNSS module

The GNSS receiver used in the LT-4130 Antenna Unit is a 72 ch. receiver with SBAS reception. The GNSS receiver performance is listed in Table 27.

GNSS receiver performance			
Data	Accuracy	Resolution	Comments
Position	GNSS: < 2.5 m SBAS: < 2 m	0.1 m	CEP, 50%, 24 hours static, -130 dBm, > 6 SVs By default, the GNSS receiver is configured for GPS, SBAS, GLONASS reception Time-To-First-Fix (cold acquisition): 26 s.
SOG	0.1 knot	0.1 knot	0 to 195 knots

Table 27: GNSS receiver performance

The GNSS receiver can be configured to the options listed in Table 28. The GPS, SBAS, GLONASS configuration is the default configuration.

GNSS Receiver configuration	
GNSS Receiver	Talker ID
GPS, SBAS, GLONASS	GN
GPS, SBAS, BeiDou	GN
GPS, SBAS	GP
GPS	GP
GLONASS	GL
BeiDou	GB

Table 28: GNSS receiver configuration

The horizontal position accuracy (static) has been measured for different configurations of the GNSS receiver, see Figure 134.

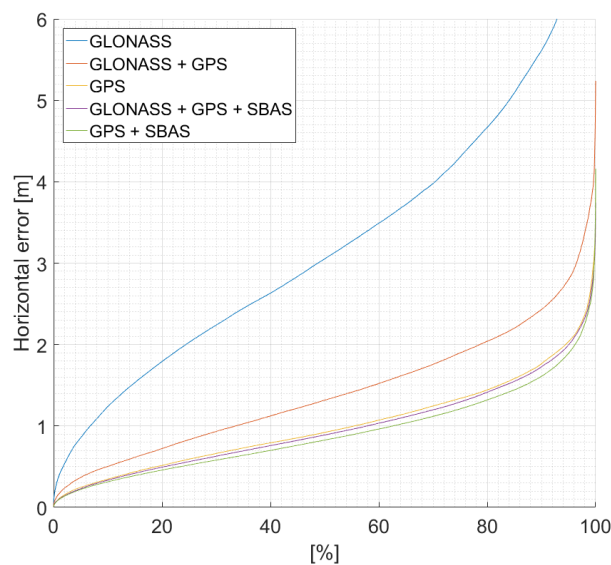

Figure 134: GNSS receiver horizontal position error

IMPORTANT: The installation of the LT-4130 Antenna Unit will affect the performance of the GNSS receiver. If line-of-sight to the GNSS satellites are disturbing the quality of the signal received by the GNSS receiver, then degraded performance must be accepted.

GNSS

The LT-4100 system supports outputting of GNSS NMEA 0183 sentences via the LT-4110 Control Unit AUX (RS-422). The AUX connector is described in detail in *Auxiliary (AUX)* on page 27. The GNSS output must be enabled via the web server, under Configuration – GNSS and BAM. The baud rate can be configured to 4.800, 9.600, or 38.400 baud. The output rate of the NMEA 0183 sentences is 1 Hz. Figure 135 below shows the NMEA 0183 sentences supported by the LT-4100 system.

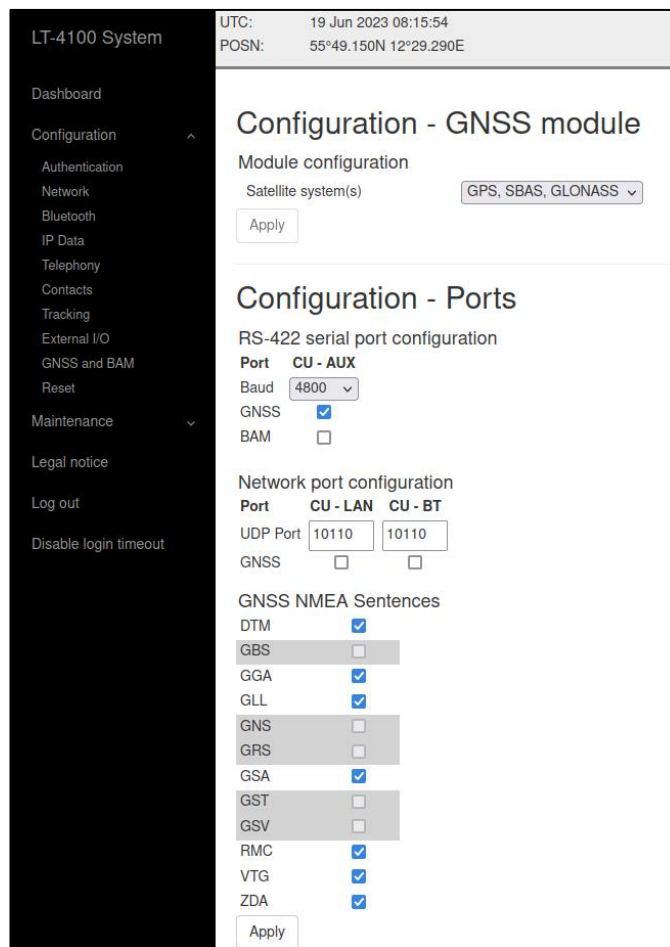

Figure 135: Web server (GNSS - NMEA 0183 sentences)

The GBS, GNS, GRS, GST and GSV sentences are not supported for the 4.800 and 9.600 baud configurations.

NOTE: Changing the GNSS receiver configuration (default: GPS, SBAS, GLONASS) might affect the NMEA 0183 Talker ID. The Talker ID for the different configurations of the GNSS receiver is listed in Table 28 on page 111.

BAM

The LT-4100 system supports BAM via the LT-4110 Control Unit AUX (RS-422) The AUX connector is described in detail in *Auxiliary (AUX)* on page 27. BAM must be enabled via the web server, under Configuration – GNSS and BAM. The baud rate can be configured to 4.800, 9.600, or 38.400 baud. For BAM configuration see Figure 136 below.

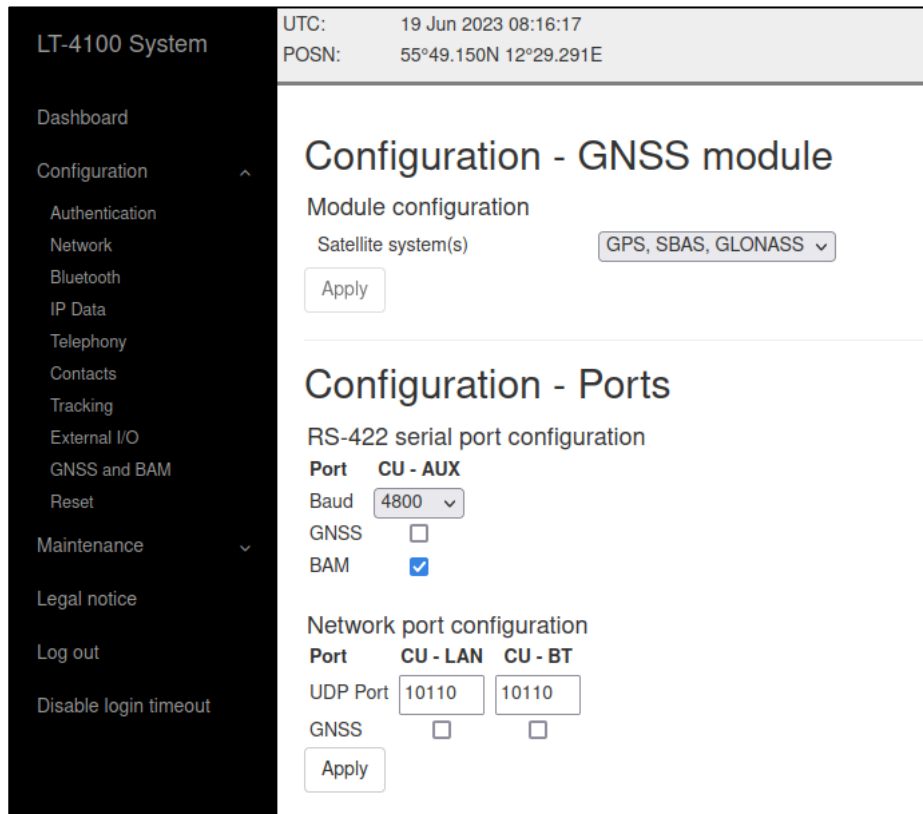

Figure 136: Web server (BAM configuration)

NOTE: The LT-4110 Control Unit AUX connector is providing one bi-directional RS-422 interface.

The Supported BAM sentences are described in *BAM sentences* on page 84.

Reset

The LT-4100 system supports reset to factory default. This reset functionality is only available via the web server, see Figure 137. By pressing ‘Reset to factory default’ and acknowledging this reset, the LT-4100 system will configure all settings to default and remove all user data (e.g. Contact List, Call History, etc.).

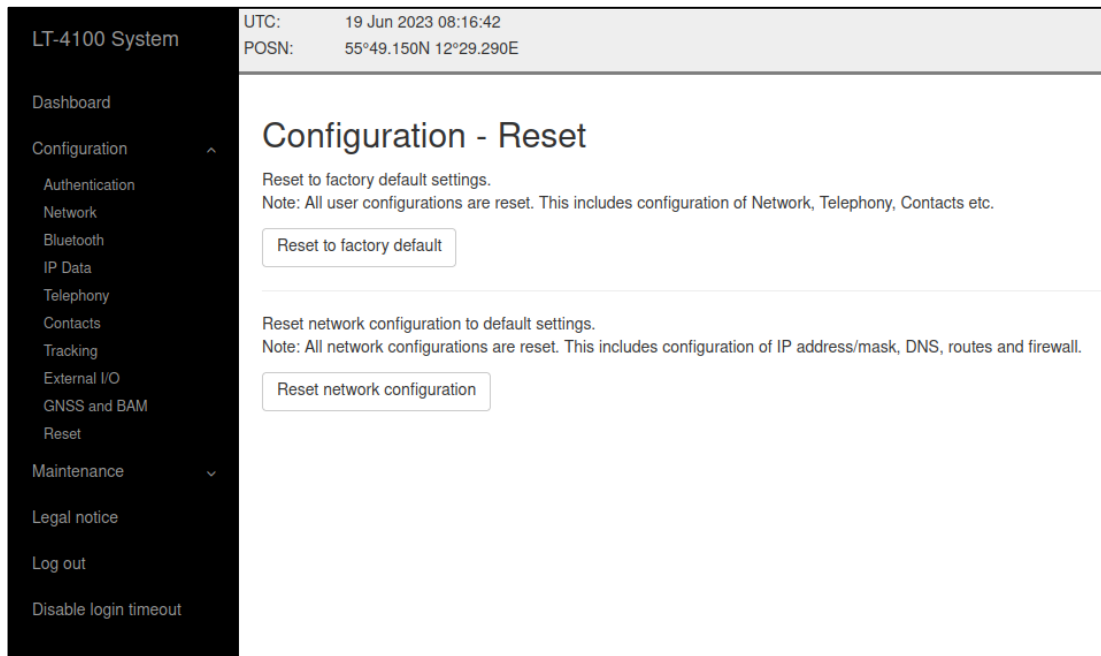

Figure 137: Web server (Reset to Factory Default)

The LT-4100 system will reboot once the factory reset has been affected.

NOTE: By ‘Reset to factory default’ the LT-4100 system will lose all settings configured and user data will be lost. The system will be operational again once it has rebooted

The default values for display and audio settings are displayed in Table 29 below.

Default Display and Audio settings	
Display, Mode	Day time
Display, Brightness	70%
Speaker volume	80%
Handset volume	60%
Ringer volume	80%
Key Beep volume	40%

Table 29: Default display and audio settings

Maintenance

Diagnostics

A diagnostic report can be downloaded from the webpage 'Diagnostics'. Navigate to the webpage and press the 'Download diagnostics report' button. A file with the following filename (example): LT-4200_00000061_191115-152149.tar.gz will be downloaded to a location selected by the user. The Diagnostics Report can be sent back to Lars Thrane A/S in case of required support and assistance. The Diagnostics Report contains data describing the current state of the system and historical events. The data can be used by support to identify issues and determine their cause.

To help identify a potential problem with the LT-4200 system it is very important that the Diagnostic Report is sent back to Lars Thrane A/S.

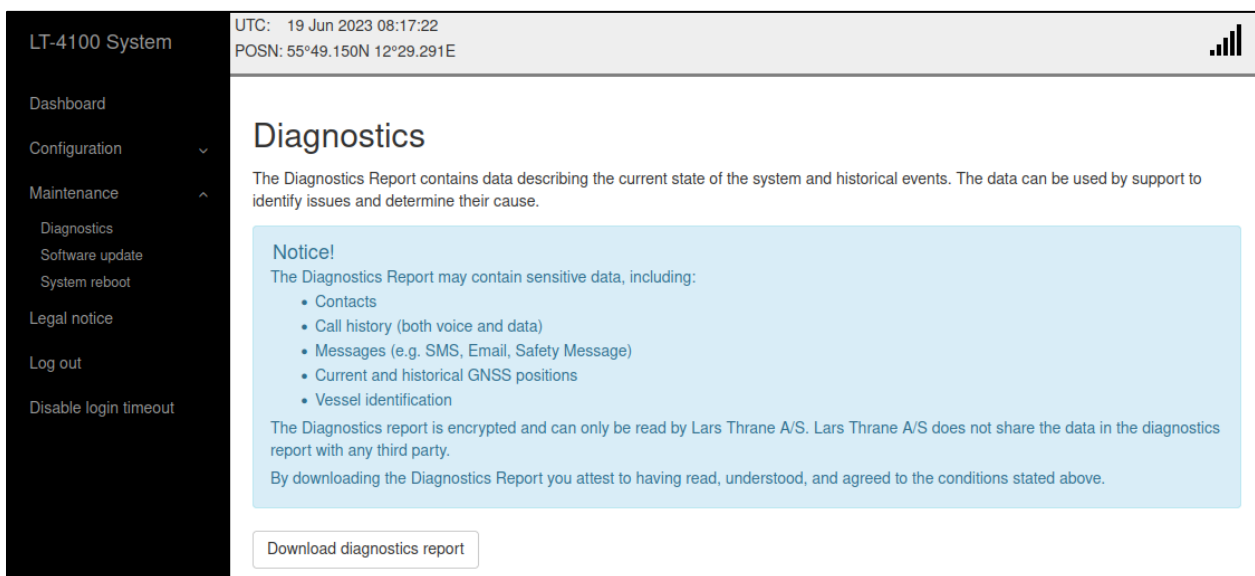

Figure 138: Web server (download diagnostics report)

NOTE: The diagnostic report is encrypted and can only be read by Lars Thrane A/S. Lars Thrane A/S does not share the data in the diagnostics report with any third party. By downloading and sending the diagnostic report to Lars Thrane A/S you attest to having read, understood, and agreed to the conditions stated under the Notice! (Highlighted in Figure 138 above).

Software update

Carefully read the software release note, provided by Lars Thrane A/S, before software updating the LT-4100 system.

Access the web server of the LT-4100 system, by following the instructions in *Accessing the built-in web server* on page 87. Select the 'Software update' web page and click the 'Choose File' button to select the LT-4100 system file, which must be uploaded to the system. The software image has the following filename (example): LT-4100-v1.00R-0003.lti - the software image and release documentation will be available on the official company website: <https://www.thrane.eu>, under the specific product or in the Partner Area. Click the 'Upload' button to start the upload of the new software image. The upload and installation of the software image will take a few minutes. Progress indication bars can be monitored on the Software update webpage, while the software update is on-going. The LT-4100 system will reboot once the software image is installed safely in all units.

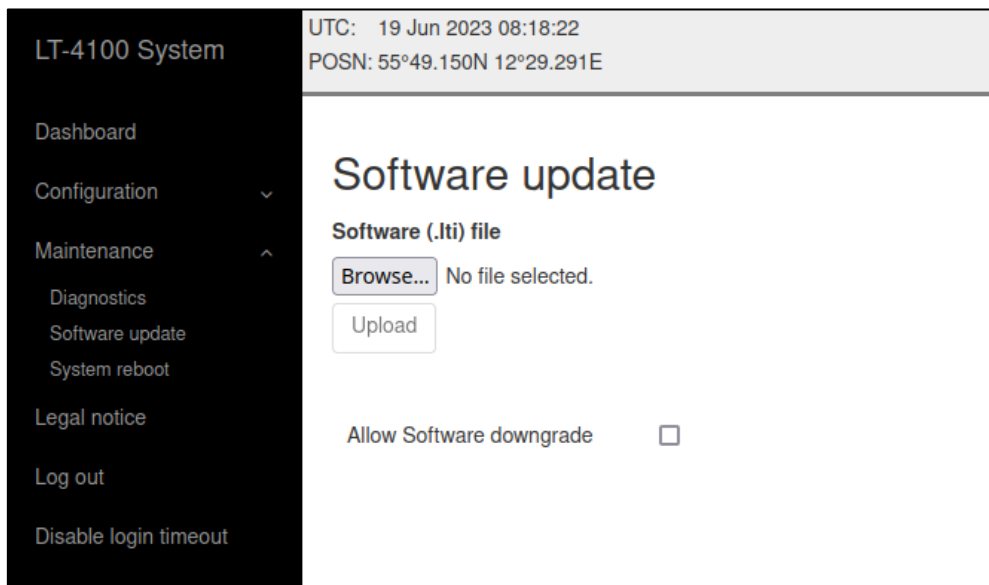

Figure 139: Web server (Software update)

- NOTE:** The LT-4110 Control Unit and LT-4130 Antenna Unit, must be operated with the same software version. The software update will happen automatically, if the control unit identifies that the software version in the antenna is different. Check or verify the web server Dashboard for software versions in each of the LT-4100 system units, see *Dashboard* on page 88.
- IMPORTANT:** Do not remove power from the control unit while the software update is on-going. Also, do not disconnect the antenna cable between the control unit and the antenna unit, while the software update is on-going.
- IMPORTANT:** The Advanced Settings shall not be used under normal circumstances. Do not use this function unless specifically instructed by Lars Thrane A/S or by the Lars Thrane A/S certified partner.

System reboot

It is possible to reboot the LT-4200 system directly from the web server using the System reboot tab. The entire LT-4200 system will be rebooted, including all connected peripheral units.

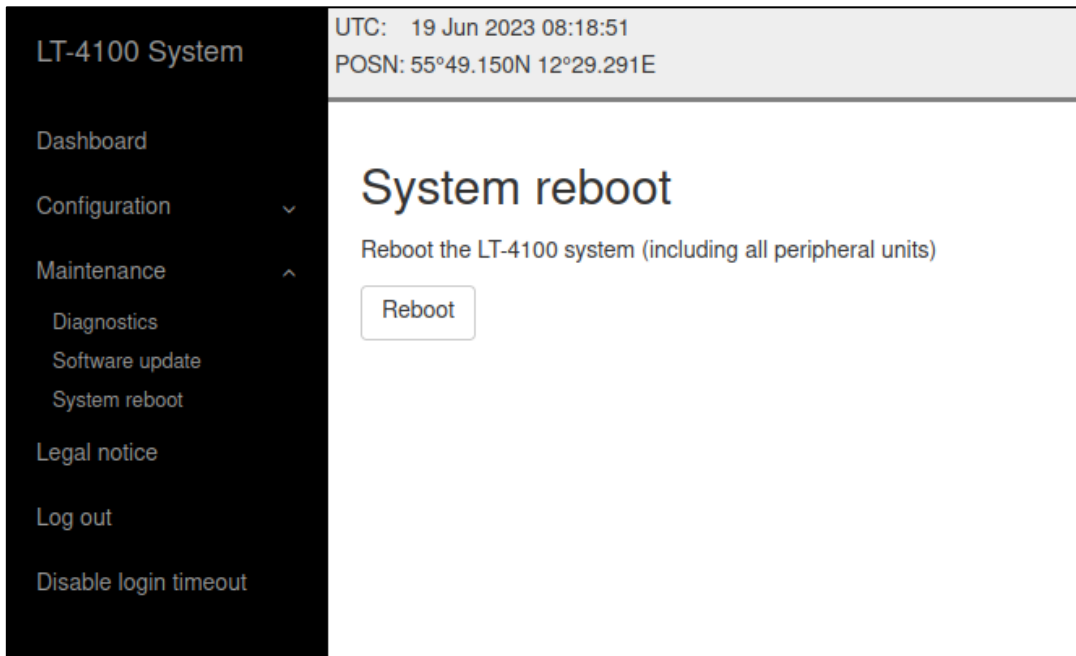

Figure 140: Web server (Software update)

Legal notice

The LT-4100 system contains Open Source software components. The Open Source software components used and related license information can be viewed by pressing the link ‘here’ under the Legal notice webpage, see Figure 141.



Figure 141: Web server (legal notice)

Log out

By pressing the ‘Log out’ webpage the web server will redirect you to the Authentication login, where it is required to use the Username and Password to re-enter the web server again. The Authentication is described in *Authentication* on page 90.

Disable login timeout

The web server will automatically logout after 5 minutes without activity. The user can disable this automatic logout by pressing the ‘Disable login timeout’ webpage, which then will change to a red color and text: ‘Enable login timeout’. The user must manually remove this configuration by pressing the webpage to go back to default settings and automatically logout.

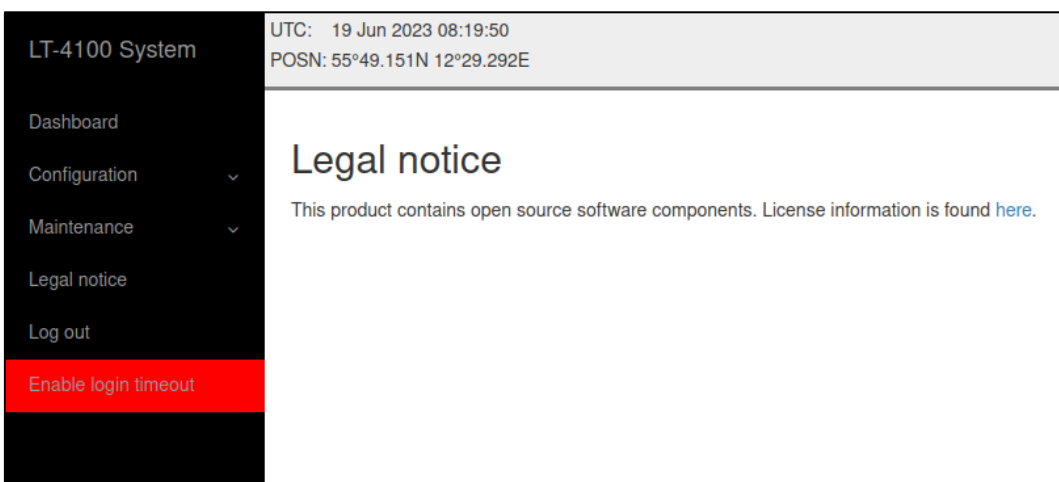

Figure 142: Web server (disable login timeout)

Service & Repair

This section describes what the end-user must do in case of required service or repair.

NOTE: The LT-4100 system does not require any scheduled maintenance or service. Make sure that the product is installed, as described in this manual, before making contact to the distributor or dealer for further assistance.

If the LT-4100 system for some reason does not work as described in this manual, contact the distributor or dealer, from where the product was originally bought. The distributor or dealer will have experience and know-how to assist with further technical support and troubleshooting.

Contacting the distributor/dealer:

- 1) Make sure to have the product name, unit part numbers, and unit serial numbers identified. The unit part numbers and the unit serial numbers are identified on the unit label, which is found on the backside, or at the bottom side of the units. Alternatively, use the built-in web server to read-out the unit part numbers and the unit serial numbers.
- 2) Write a technical report about the observation or error. If possible, attach a picture of the installed product and include a wiring diagram. If possible, download a diagnostic report as described in *Diagnostics* on page 115.
- 3) Send all information to the local distributor or dealer.

IMPORTANT: Unless otherwise agreed, the end-user shall always coordinate service and repair issues directly with the distributor or dealer. This practice also applies for returning of products for service and repair.

All information that will get back to Lars Thrane A/S, either directly or indirectly, will be handled with confidentiality. End-user sensitive data will not be shared with any third party without prior written acceptance from the involved parties.

Appendixes

App. A Applicable Standards

- [1] IEC 62923-1
Maritime navigation and radiocommunication equipment and systems - Bridge alert management
Part 1: Operational and performance requirements, methods of testing and required test results
- [2] IEC 62923-2
Maritime navigation and radiocommunication equipment and systems - Bridge alert management
Part 2: Alert and cluster identifiers and other additional features

App. B Bridge Alert Management (BAM)

Alert generating functions

Name	Can be deactivated	Description
SIM	No	Responsible for managing the Certus Subscriber Identity Module (SIM) card. It is not possible to deactivate this function.

Table 30: Alert generating functions

The LT-4100 system contains the following functions capable of raising.

Alert categories

The BAM concept groups alerts into categories as a mean to indicate where an alert may be acknowledged (and thus also whether it can have its responsibility transferred):

Category	Description
A	Alert for which additional information at the alert source is necessary, as decision support for the evaluation of the alert related condition. Alert can only be acknowledged at the alert source.
B	Alert where no additional information for decision support is necessary besides the information which can be presented at the CAM UI. Alert may be acknowledged at the alert source and/or the CAM system.
C	Alert that cannot be acknowledged on the bridge but for which information is required about the status and treatment of the alert.

Table 31: BAM alert categories

List of alerts

ID:	3022	Priority:	Warning	Category:	B	Resp. transfer:	Yes
Title:	Power fail		Can ACK:	Yes	Transitory:	No	
Description:	CU input voltage too high. Check power supply						
What to do:	Check the output voltage of the power supply						
Conditions:	Raised when the Control Unit detects a too high input voltage. Rectified when the input voltage is normalized						
Escalation:	Repeated as a warning after 90 s.						

ID:	3022	Priority:	Warning	Category:	B	Resp. transfer:	Yes
Title:	Power fail		Can ACK:	Yes	Transitory:	No	
Description:	CU input voltage too low. Check power supply						
What to do:	Check the output voltage of the power supply						
Conditions:	Raised when the Control Unit detects a too low input voltage. Rectified when the input voltage is normalized						
Escalation:	Repeated as a warning after 90 s.						

ID:	3022	Priority:	Warning	Category:	B	Resp. transfer:	Yes
Title:	Power fail		Can ACK:	Yes	Transitory:	No	
Description:	AU input voltage too low. Refer to user manual						
What to do:	Check the DC resistance of the coaxial cable is below the maximum allowed as specified in LT-4130 Antenna Unit on page 32.						
Conditions:	Raised when the Antenna Unit detects a too low input voltage. Rectified when the input voltage is normalized						
Escalation:	Repeated as a warning after 90 s.						

ID:	3116	Priority:	Caution	Category:	B
Title:	Lost connection				
Description:	Check satellite terminal				
What to do:	Verify the Antenna Unit has free line of sight to the sky. Remove any object blocking the line of sight if possible.				
Conditions:	Raised when the terminal has been unable to detect or otherwise contact the satellites of the Iridium® satellite system for a period of one minute or more. Rectified when the terminal detects the Iridium® satellite system.				

ID:	11412	Priority:	Warning	Category:	B	Resp. transfer:	Yes
Title:	Lost antenna		Can ACK:	Yes	Transitory:	No	
Description:	Iridium service unavailable. Check antenna cable						
What to do:	Check the cable between the Control Unit and the Antenna Unit.						
Conditions:	Raised when Control Unit loose connection with the Antenna Unit Rectified when connection is reestablished with the Antenna Unit.						
Escalation:	Repeated as a warning after 90 s.						

ID:	11412	Priority:	Warning	Category:	B	Resp. transfer:	Yes
Title:	Lost handset		Can ACK:	Yes	Transitory:	No	
Description:	Voice calls unavailable. Check handset cable						
What to do:	Check the cable between the handset and the Control Unit						
Conditions:	Raised when Control Unit loose connection with the Handset Rectified when connection is reestablished with the Handset.						
Escalation:	Repeated as a warning after 90 s.						

ID:	11422	Priority:	Warning	Category:	B	Resp. transfer:	Yes
Title:	Software fault			Can ACK:	Yes	Transitory:	No
Description:	Software does not support hardware						
What to do:	Install the latest software.						
Conditions:	Raised when the software detects hardware that is not supported by the software.						
Escalation:	Repeated as a warning after 90 s.						

ID:	11422	Priority:	Warning	Category:	B	Resp. transfer:	Yes
Title:	Software fault			Can ACK:	Yes	Transitory:	No
Description:	Please reinstall software						
What to do:	Install the latest software.						
Conditions:	Raised when a software updated completed in failure.						
Escalation:	Repeated as a warning after 90 s.						

ID:	15102	Priority:	Warning	Category:	B	Resp. transfer:	Yes
Title:	Lost SIM card			Can ACK:	Yes	Transitory:	No
Description:	Check SIM card						
What to do:	Verify the SIM card is properly inserted (see <i>Certus SIM card (SIM)</i> on page 25).						
Conditions:	Raised when the SIM card is removed or cannot be detected. Rectified when the SIM card is detected.						
Escalation:	Repeated as a warning after 90 s.						

App. C Multiple talkers and multiple listeners

IEC 61162 *Multiple talkers and multiple listeners* is a series of protocol definitions supporting both RS-422 and Ethernet for transporting its messages.

LT-4100 system currently supports IEC 61162 over RS-422 only but is prepared for future support of IEC 61162 over Ethernet. Certification of compliance with IEC 61162-450 and IEC 61162-460 has been obtained and thus the LT-4100 system is permitted to be connected to an IEC 61162 Ethernet network, though none of their functions are supported.

ONF network node

The LT-4100 system is classified as an ONF network node by IEC 61162 using the following protocols: DHCP, IPv4, IPv4LL, UDP, TCP, SIP, RTP, HTTP, HTTPS.

App. D GNSS sentences

This appendix provides detailed information about the GNSS sentences supported by the LT-4100 system. For further details see *GNSS sentences* on page 83 and web server configuration *GNSS and BAM* on page 110.

GNSS Talker identification mnemonics

The LT-4100 system may use the following talker identifiers:

GNSS Talker Identification Mnemonics		
Talker Device	Identifier	Function
Global Navigation Satellite System (GNSS)	GN	GNSS
Global Positioning System (GPS)	GP	GNSS
GLONASS positioning system	GL	GNSS
BeiDou positioning system	GB	GNSS

Table 32: GNSS Talker identification mnemonics

GNSS Talker Sentence Overview

GNSS Talker Sentences			
Sentence Formatter	Function	Description	Transmission Interval
DTM	GNSS	Datum reference	1 s
GGA	GNSS	Global positioning system (GPS) fix data	1 s
GLL	GNSS	Geographic position – latitude / longitude	1 s
GSA	GNSS	GNSS DOP and active satellites	1 s
GSV	GNSS	GNSS satellites in view	1 s
RMC	GNSS	Recommended minimum specific GNSS data	1 s
VTG	GNSS	Course over ground and ground speed	1 s
ZDA	GNSS	Time and date	1 s

Table 33: GNSS Talker Sentences

The table below lists all GNSS sentences the LT-4100 system can transmit (as a talker):

GNSS Listener sentences overview

No listener sentences available for GNSS.

App. E BAM Sentences

This appendix provides detailed information about the BAM sentences supported by the LT-4100 system. For further details see *BAM sentences* on page 84 and web server configuration *GNSS and BAM* on page 110.

BAM Talker identification mnemonics

The LT-4100 system may use the following talker identifiers:

BAM Talker Identification Mnemonics		
Talker Device	Identifier	Function
Communications - satellite	CS	BAM

Table 34: BAM talker identification mnemonics

BAM Talker Sentence Overview

BAM Talker Sentences			
Sentence Formatter	Function	Description	Transmission Interval
ALC	BAM	Cyclic alert list	30 s
ALF	BAM	Alert sentence	n/a
ARC	BAM	Alert command refused	n/a

Table 35: BAM talker sentences

The table below lists all BAM sentences the LT-4100 system can transmit (as a talker):

BAM Listener sentences overview

BAM Listener Sentences			
Sentence Formatter	Function	Description	Presence
ACN	BAM	Alert command	Optional
HBT	BAM	Heartbeat supervision sentences	Optional

Table 36: BAM listener sentences

The table below lists all sentences the LT-4100 system can receive (as a listener):

App. F GNSS Receiver Integrity States

The LT-4100 system has a built-in GNSS receiver located in the LT-4130 Antenna Unit. The GNSS receiver is used under normal conditions for providing the LT-4100 system with time, data, and position information to all required functions in the system. GNSS Status is located in the System submenu (MENU -> System) described and illustrated in *System* starting on page 74. Table 37 illustrates the GNSS receiver integrity states. The color marking has the following meaning:

- Colored Yellow -> low integrity
- Colored Orange-> Invalid

GNSS Receiver Integrity States (Automatic GNSS)							
State	UTC	POSN	POSN (age)	Horizontal Accuracy	COG [°]	SOG [kts]	Comments
System has just booted and there is not yet a fix	Acquiring...	Acquiring...	-	-	-	-	System booting up
System has just booted and only time is known	Time	Acquiring...	-	-	-	-	System booting up
Horizontal accuracy > 50 m (SOG = 0 kts)	Time	Lat/Long	Up to date	> 50 m	XXX.X	XX.X	System booting up
Horizontal accuracy < 50 m (SOG = 0 kts)	Time	Lat/Long	Up to date	< 50 m	XXX.X	XX.X	Normal GNSS receiver state.
SOG > 1 m/s (~ 2 kts)	Time	Lat/Long	Up to date	< 50 m	XXX.X	XX.X	Normal GNSS receiver state.
GNSS fix completely lost (last known position has age > 0 min)	Time (old)	Lat/Long	> 0 min	-	-	-	No fix on GNSS receiver (time and position).
GNSS fix completely lost (last known position has age 23 hours 59 min)	Time (old)	Lat/Long	≤ 23 hours 59 min	-	-	-	No fix on GNSS receiver (time and position).
GNSS fix completely lost (last known position has age ≥ 24 hours)	Time (old)	Lat/Long Acquiring...	≥ 24 hours	-	-	-	No fix on GNSS receiver (time and position).

Table 37: GNSS Receiver Integrity States (Automatic GNSS)

Table 37 is illustrating the GNSS receiver integrity states .The following pages will illustrate all relevant states.

System has just booted and there is not yet a fix

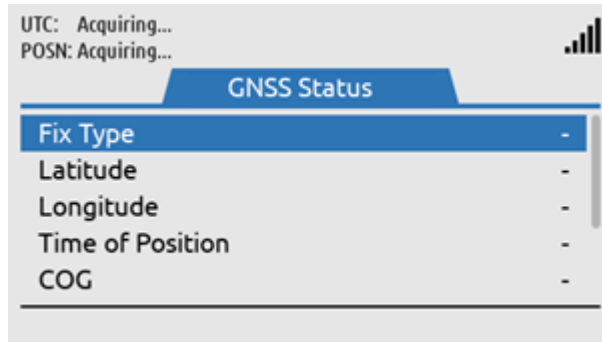

Figure 143: GNSS Receiver Integrity State

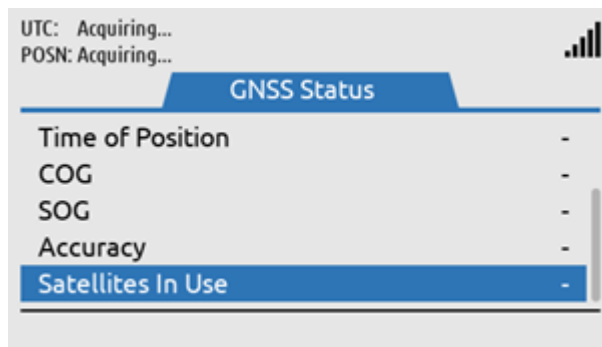

Figure 144: GNSS Receiver Integrity State

System has just booted and only time is known

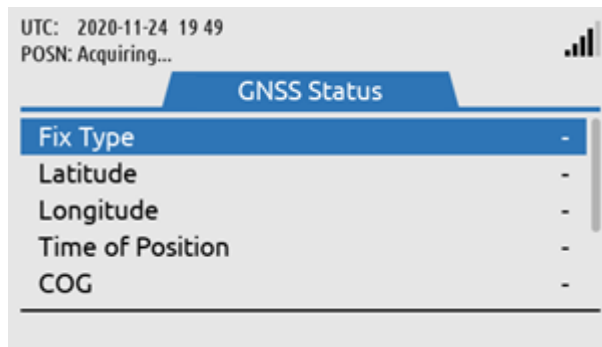

Figure 145: GNSS Receiver Integrity State

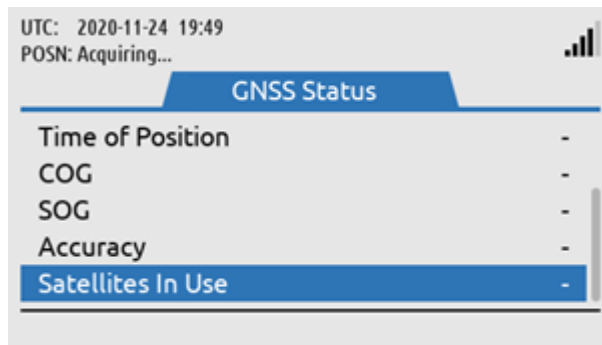

Figure 146: GNSS Receiver Integrity State

Horizontal accuracy > 50 m (SOG = 0 kts)

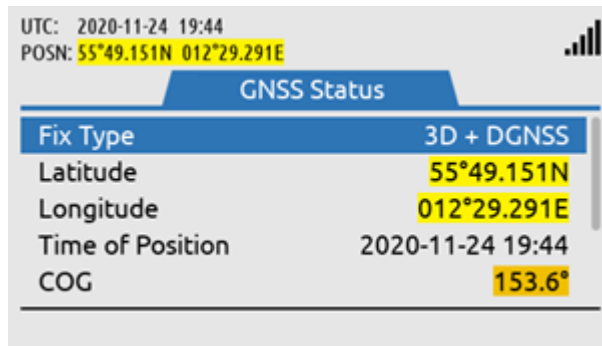

Figure 147: GNSS Receiver Integrity State

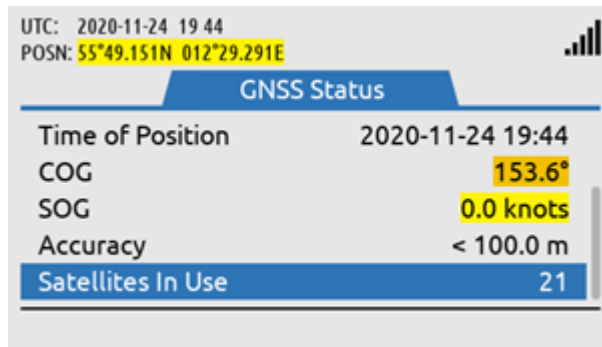

Figure 148: GNSS Receiver Integrity State

Horizontal accuracy < 50 m (SOG = 0 kts)

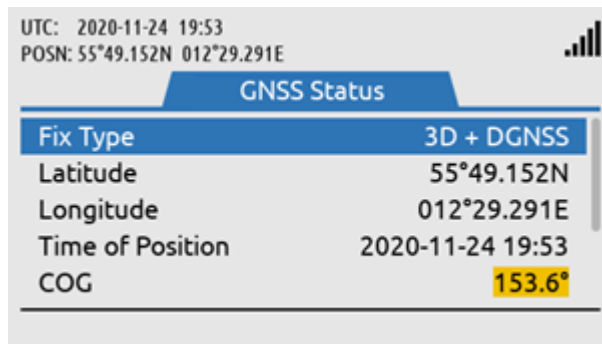

Figure 149: GNSS Receiver Integrity State

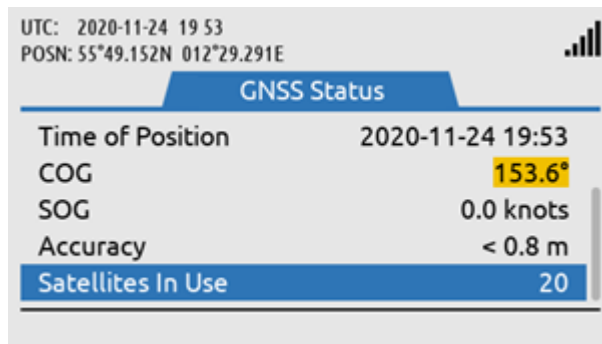

Figure 150: GNSS Receiver Integrity State

SOG > 1 m/s (~ 2 kts)

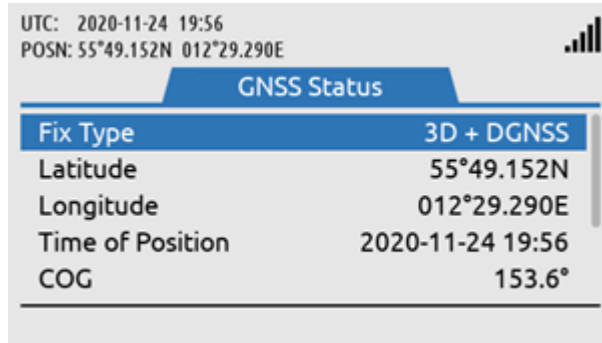

Figure 151: GNSS Receiver Integrity State

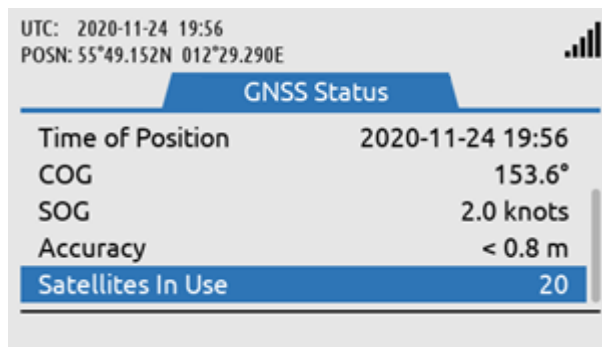

Figure 152: GNSS Receiver Integrity State

GNSS fix completely lost (last known position has age 10 min)

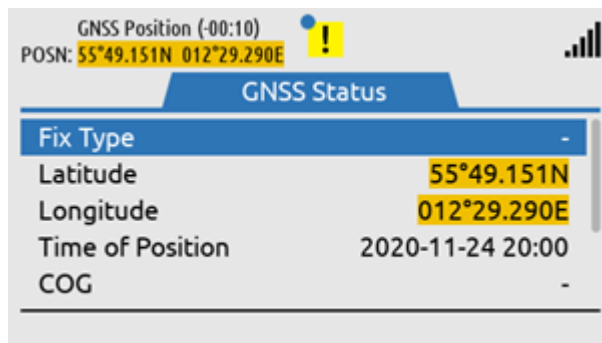

Figure 153: GNSS Receiver Integrity State

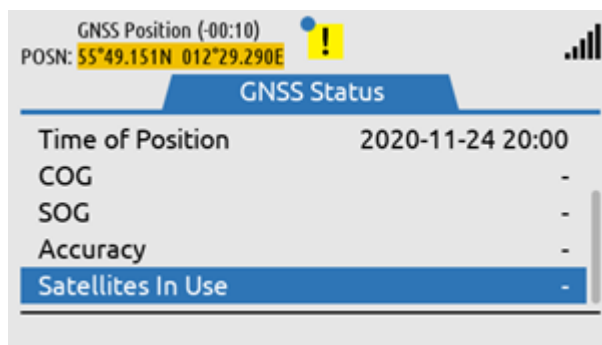

Figure 154: GNSS Receiver Integrity State

GNSS fix completely lost (last known position has age 23 hours 59 min)

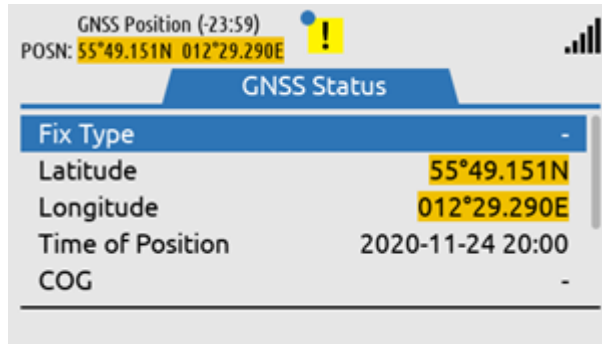

Figure 155: GNSS Receiver Integrity State

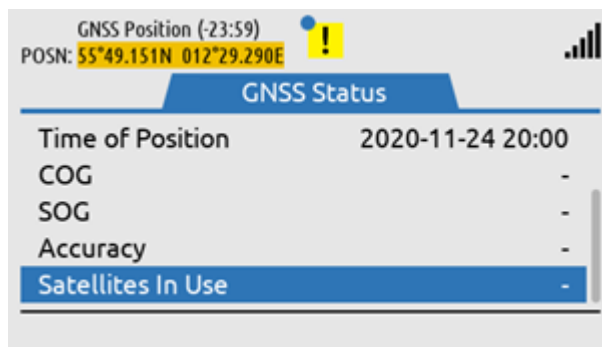

Figure 156: GNSS Receiver Integrity State

GNSS fix completely lost (last known position has age >= 24 hours)

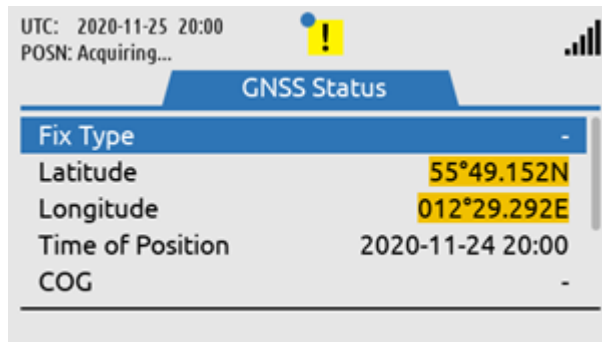

Figure 157: GNSS Receiver Integrity State

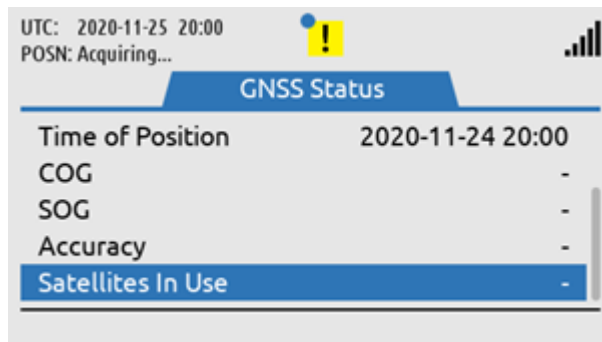

Figure 158: GNSS Receiver Integrity State

App. G - Specifications**LT-4100 Satellite Communications System**

Certification & standards	RED, FCC, ISED, RoHS 2, Iridium®
Vibration, operational	IEC 60945
Vibration, shock	Half sine 20 g/11 ms
Power consumption: operating mode, max	24 W
Power consumption: Idle	9 W
BAM EUT function types	P

LT-4110 Control Unit

Weight	0.67 kg (1.48 lbs)
Dimensions	224.0 x 120.0 x 70.0 mm (8.82 x 4.72 x 2.76 in)
Temperature, operational	-15°C to +55°C (+5°F to +131°F)
IP rating, dust and water	IP32
Interfaces	Ethernet, auxiliary, DC input, chassis ground Antenna Unit (N conn.), handset, Bluetooth, SIM card
Input power	12-24 VDC (2.0-1.0 A)
BT transmitter, Max RF output power	10 mW
BT transmitter, Frequency bands	TX: 2402-2480MHz, RX:2402-2480MHz
Compass Safe Distance, std.	0.60 m (2.0 ft)
Compass Safe Distance, steer.	0.40 m (1.3 ft)

LT-3120 Handset

Weight	0.30 kg (0.66 lbs)
Dimensions	52.8 x 208.8 x 38.2 mm (2.08 x 2.08 x 1.50 in)
Temperature, operational	-15°C to +55°C (+5°F to +131°F)
IP rating, dust and water	IP32
Compass Safe Distance, std.	0.60 m (2.0 ft)
Compass Safe Distance, steer.	0.35 m (1.1 ft)

LT-3121 Cradle

Weight	66 g (0.15 lbs)
Dimensions	106.9 x 57.4 x 29.3 mm (4.21 x 2.26 x 1.15 in)
Compass Safe Distance, std.	1.40 m (4.6 ft)
Compass Safe Distance, steer.	0.90 m (3.0 ft)

LT-4130 Antenna Unit

Weight	1.39 kg (3.05 lbs)
Dimensions	182 x Ø 162 mm (7.16 x Ø 6.39 in)
Temperature, operational	-40°C to +55°C (-40°F to +131°F)
IP rating, dust and water	IP67
Interfaces	Control Unit (N conn.)
Antenna communication cable	Coaxial cable, up to 500 m (1500 ft)
Compass Safe Distance, std.	0.30 m (1.0 ft)
Compass Safe Distance, steer.	0.30 m (1.0 ft)

Warranty	2 years
Maintenance	None

*When 12 VDC input power is used, the maximum cable length will be reduced.

App. H - Outline Drawing: LT-4110 Control Unit

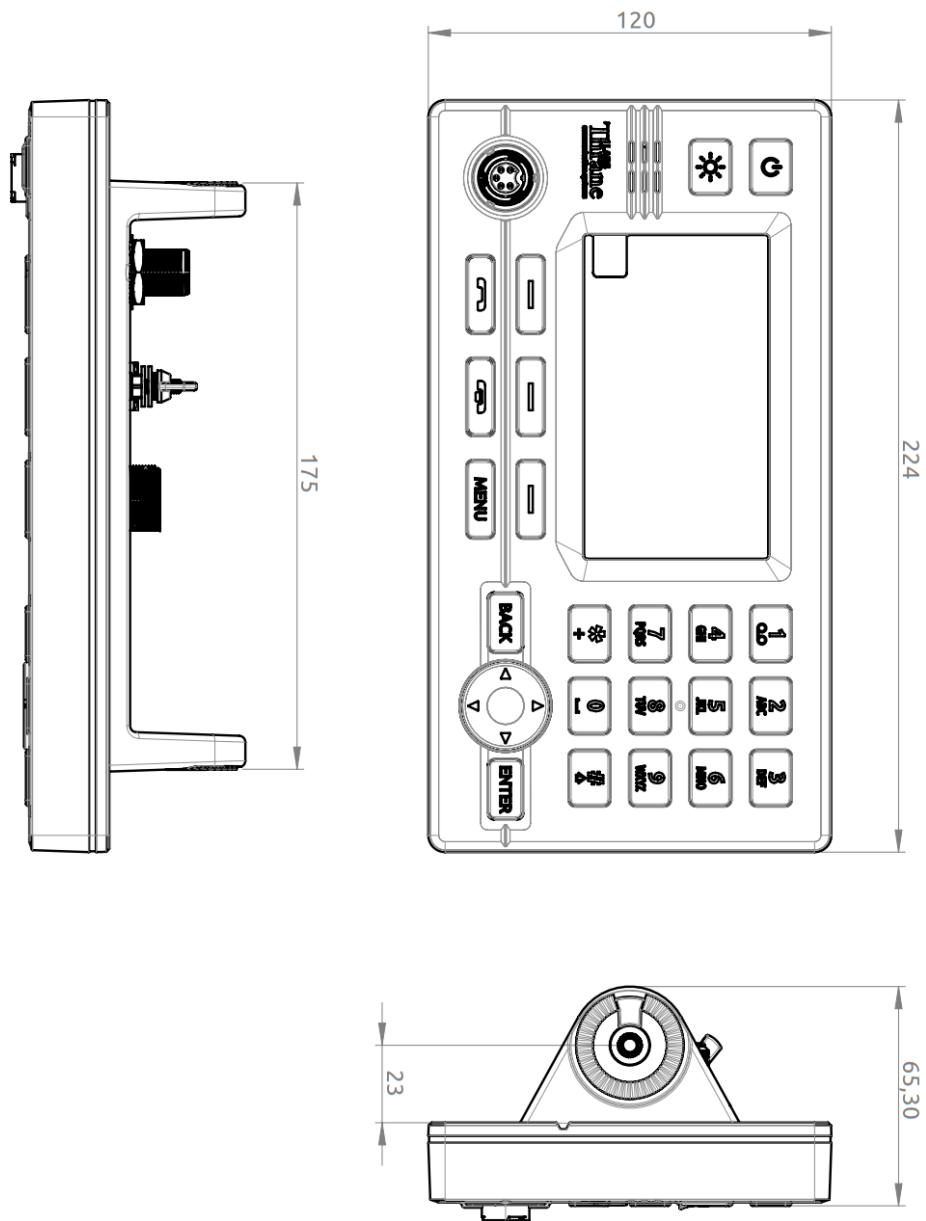

Figure 159: Outline Drawing: LT-4110 Control Unit

App. I - Outline Drawing: Bracket Mount, Control Unit

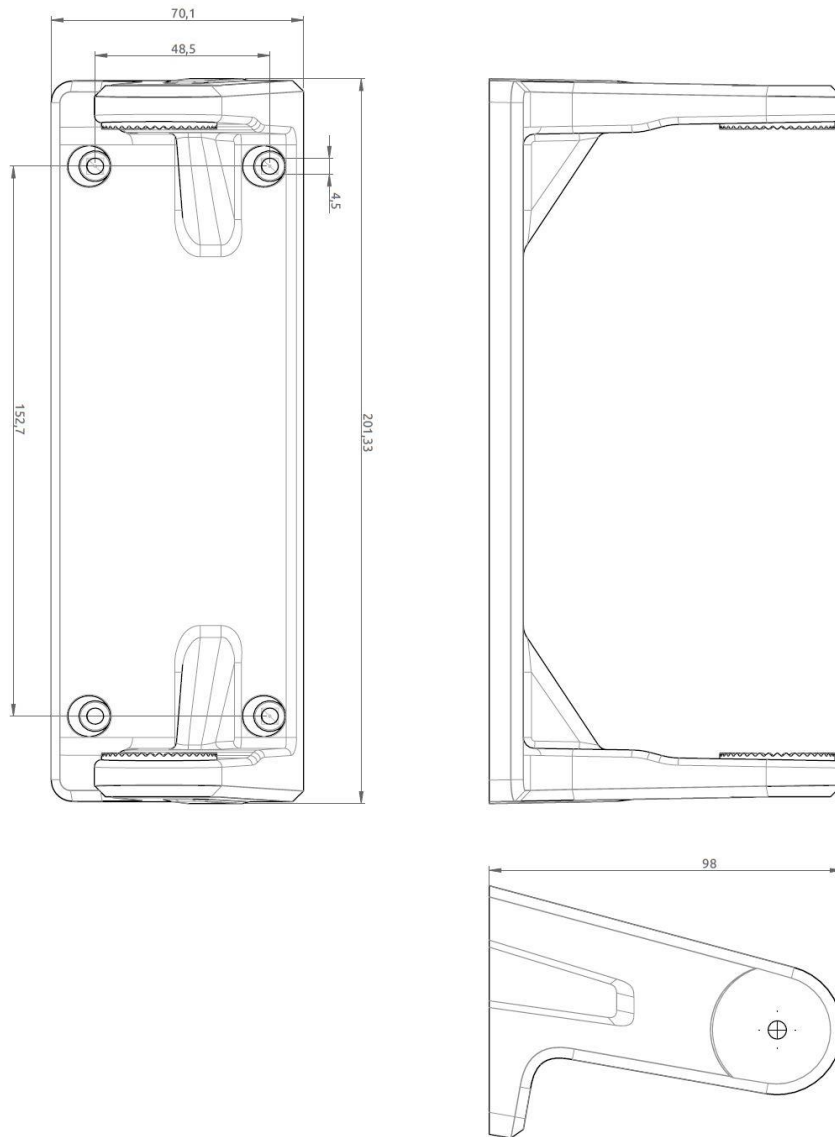

Figure 160: Outline Drawing: Bracket Mount, Control Unit

App. J - Outline Drawing: Flush Mount, Control Unit

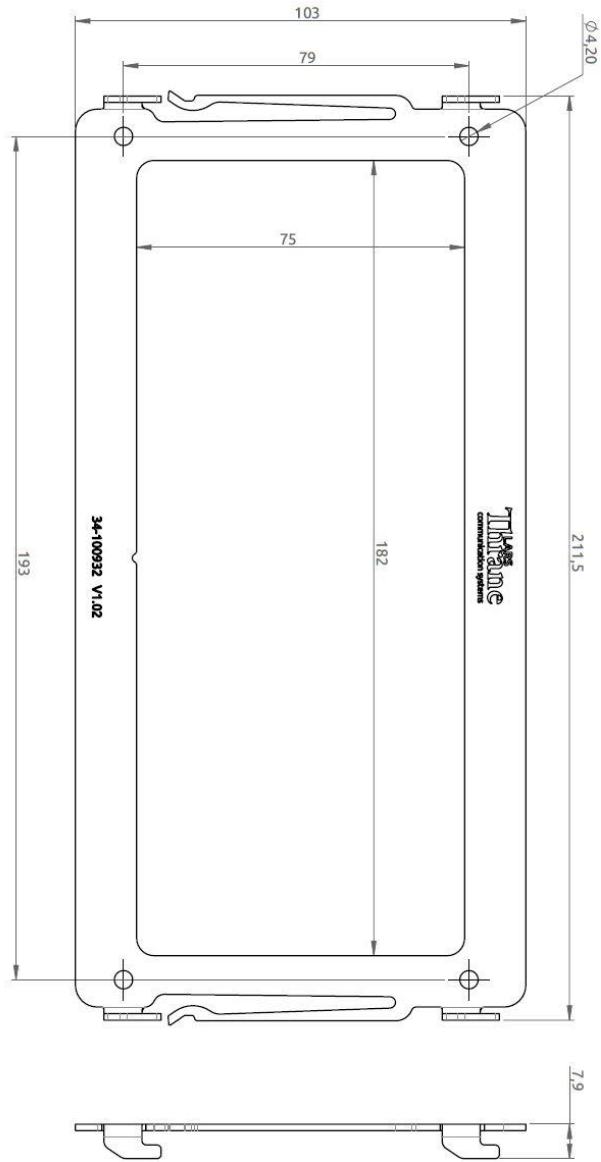

Figure 161: Outline Drawing: Flush Mount, Control Unit

App. K - Outline Drawing: LT-4130 Antenna Unit

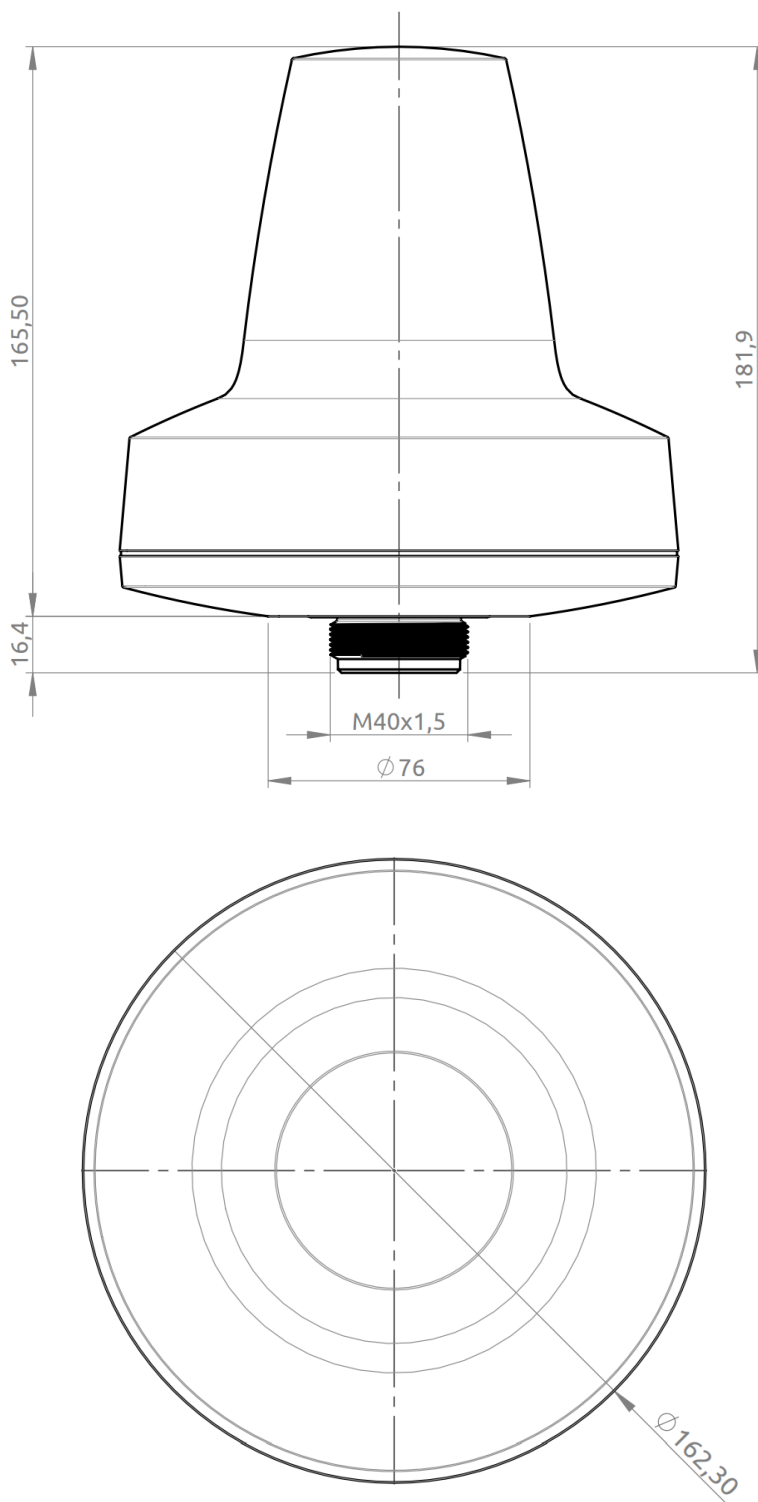

Figure 162: Outline Drawing: LT-4130 Antenna Unit

App. L - Outline Drawing: Pole Mount (1.5" pipe, 38.8mm), Antenna Unit

NOTE: The Pole Mount (1.5" pipe, 38.8mm), Antenna Unit interfaces to a pipe of maximum 1.5" (38.8 mm), measured outer diameter. The total weight of the Pole Mount is 190 g (0.42 lbs).

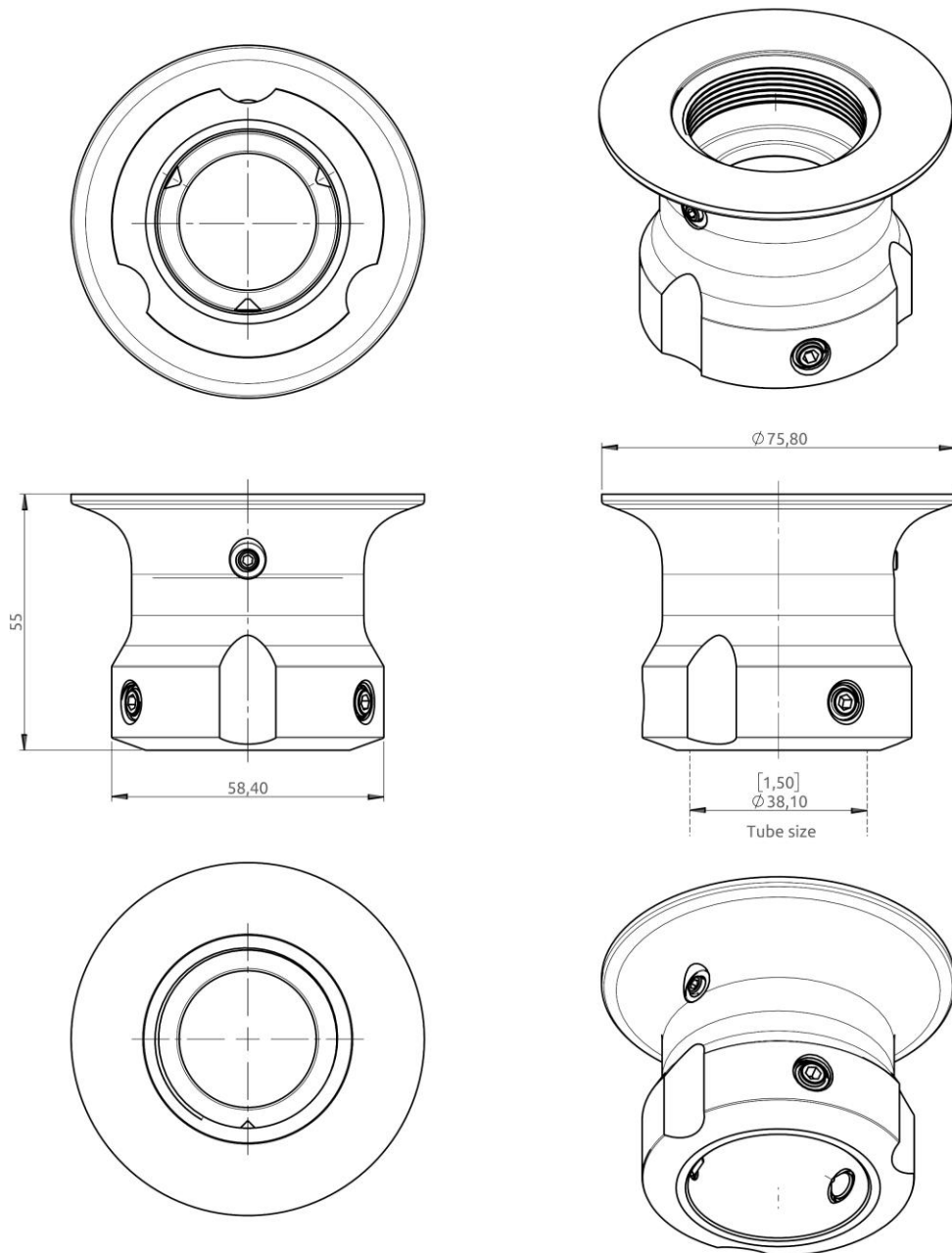

Figure 163: Outline Drawing: Pole Mount (1.5" pipe), Antenna Unit

App. M - Outline Drawing: Pole Mount (2.0" pipe, 53.0mm), Antenna Unit

NOTE: The Pole Mount (2.0" pipe, 53.0mm), Antenna Unit interfaces to a pipe of maximum 2.0" (53.0 mm), measured outer diameter. The total weight of the Pole Mount is 240 g (0.53 lbs).

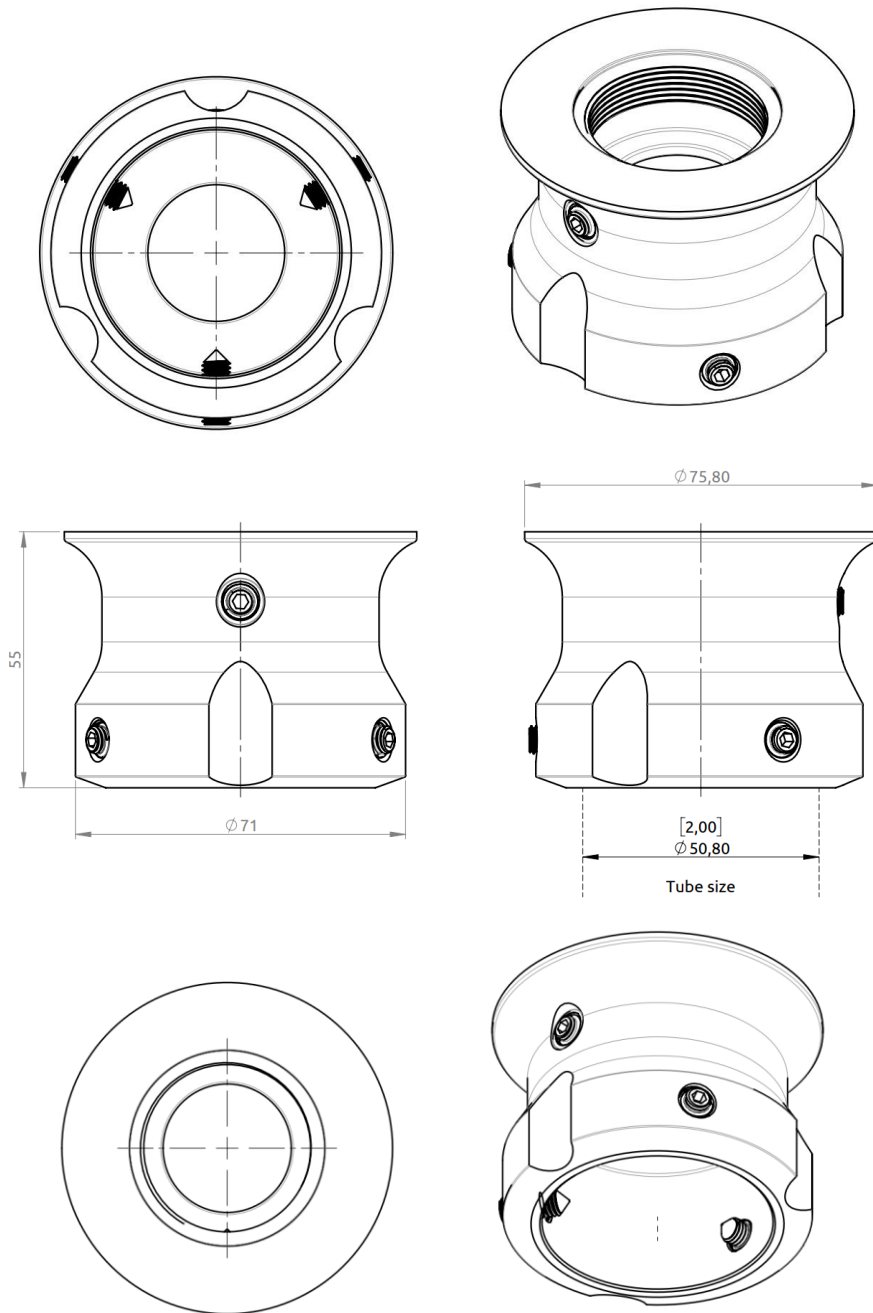

Figure 164: Outline Drawing: Pole Mount (2.0" pipe), Antenna Unit

App. N - Outline Drawing: LT-3120 Handset

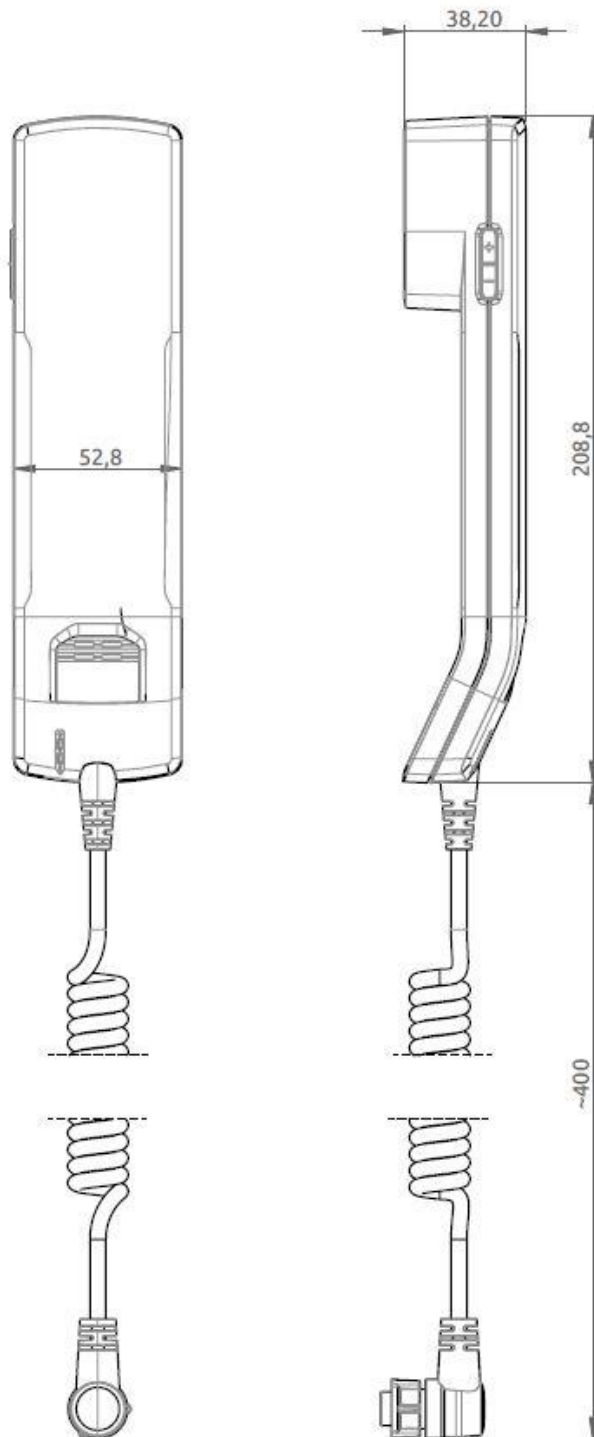

Figure 165: Outline Drawing: LT-3120 Handset

App. O - Outline Drawing: LT-3121 Cradle

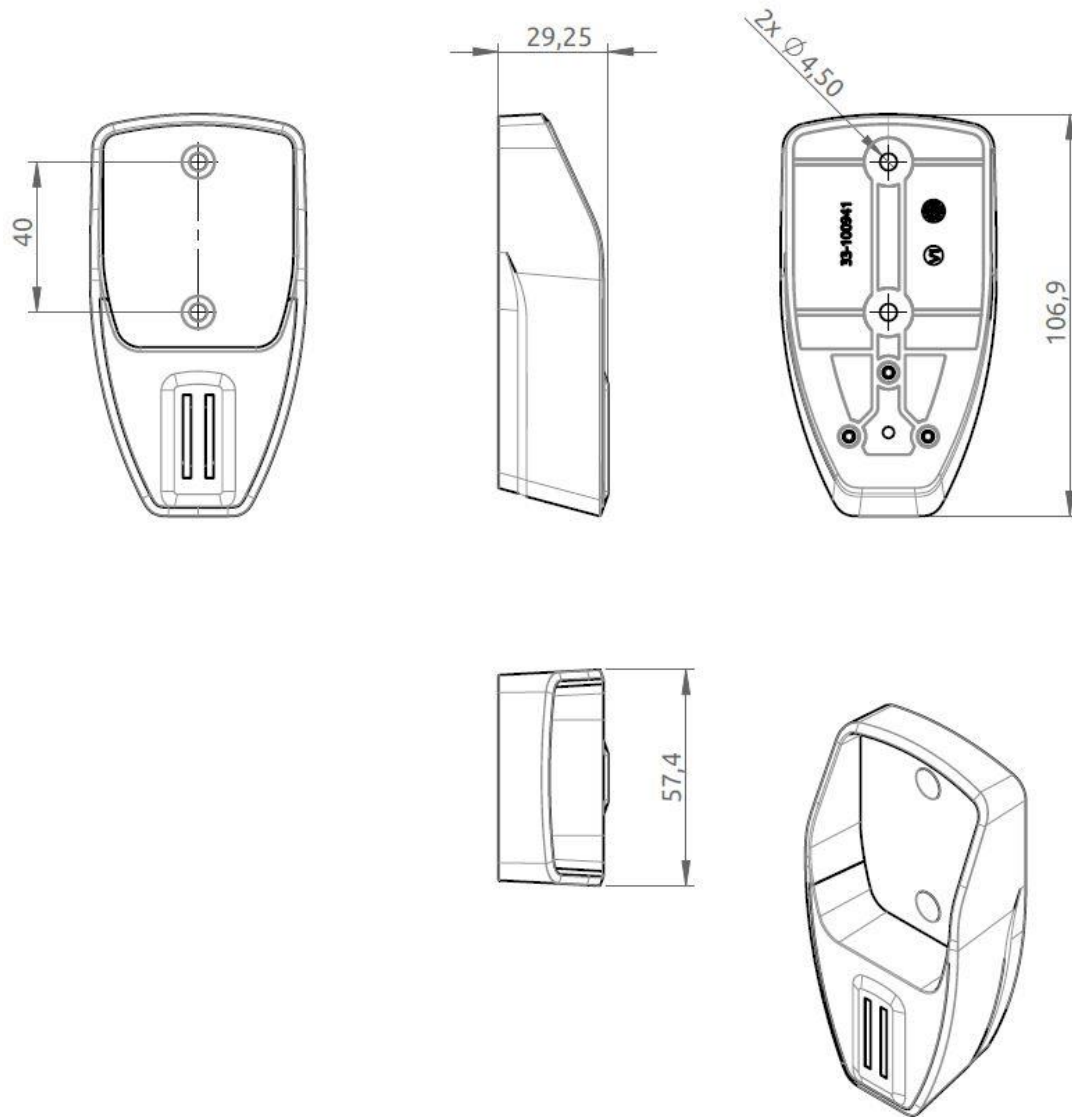

Figure 166: Outline Drawing: LT-3121 Cradle

Lars Thrane A/S

Skovlytoften 33

2840 Holte

Denmark

www.thrane.eu